

COLLECTORS NO. 40052



Bookcase
Circa 1740

In today's world, we take books and other printed matter for granted. In the world of our ancestors, printed material was a luxury. When it was acquired, it was protected like any other fine possession.

With the increase in the availability of books in the colonies, bookcases, like the one we have reproduced in miniature, became popular. At first, these were built with solid wooden doors. When glass became available, they were built with doors such as those on our fine piece of furniture.

Since books were a luxury and a symbol of the owner's education and community status, they were prominently displayed for all to see. The large storage drawer in the base was probably used to store unbound publications, maps, etc.

If the owner was not able to acquire enough books to fill the case, other fine possessions such as vases, and statuary were displayed inside the bookcase.

This particular case graced a fine Virginia home and will feel equally at home in your miniature mansion.

ASSEMBLY AND FINISHING INSTRUCTIONS



AUTHENTIC REPRODUCTIONS IN MINIATURE

The X-ACTO® House of Miniatures® Collectors Series of furniture and accessories have all been carefully researched by specialists through major museum and library collections to assure the highest quality of authenticity in reproduction. Details are extraordinarily accurate to satisfy the most discriminating miniaturist.

All wood parts are machined to assure accurate and precise acceptance of each piece by another.

For a complete catalog of the X-ACTO® HOUSE OF MINIATURES furniture line and accessories, write to:

X-ACTO® THE HOUSE OF MINIATURES Dept. KIT
45-35 Van Dam Street
Long Island City,
New York 11101

Please include \$2.00 for postage and handling.

TOOLS AND MATERIALS

A. The following tools will be helpful in constructing this kit:

1. Two-inch Sander, X-ACTO No. 7042
2. Large Clamp, X-ACTO No. 4004
3. Small Clamp, X-ACTO No. 4003
4. X-ACTO Professional Finishing Kit (or equivalent, see note)

B. The following materials will be needed to construct this kit:

1. X-ACTO Tinted Glue (see note)
2. Waxed paper
3. Sandpaper - 220 and 280 grit
4. Steel Wool - Grade 0000
5. White glue (or equivalent)
6. Small Artist's Brush

NOTE: The X-ACTO tinted glue is matched to the finish used in the Professional Finishing Kit. This will produce the authentic finish of the period in which the original Furniture was produced. When not using X-ACTO glue follow manufacturer's directions.

GLUING

- A. Glue should be applied in small amounts to surface being joined. When gluing dado joints apply glue to dado only.
- B. To ensure a tight fit, squeeze excess glue out of the joints. Hold glued parts together with clamps, rubber bands or weights on the parts.
- C. Wipe off excess glue promptly.
- D. Be sure a glued assembly has dried thoroughly before adding parts.

FINISHING

The X-ACTO Professional Finishing Kit enables you to finish your furniture by the same process used by the professional furniture maker. The end result is what is important — there are easier methods, but none that will give the quality results that this process will. If you use a finish other than X-ACTO's, refer to the manufacturer's directions.

INTRODUCTION

BEFORE STARTING

Identify and account for each part by placing it on the Layout Sheet (make sure the correct layout sheet is used when working on multi-kit Instruction Sheets). Should any parts be missing, send a post card to:

X-ACTO/The House of Miniatures
45-35 Van Dam Street
Long Island City, N.Y. 11101

Please print Name, Address, Part Number (Number from Layout Sheet) and Kit Name and Number on card when ordering.

SANDING

Before assembly, sand all the outer surfaces of individual parts with 220 grit sandpaper, or finer, sanded in the same direction as the wood grain until the surface is smooth. Take care not to round any edges or corners of the pieces. Finish sanding with 280 grit sandpaper.

PRE-ASSEMBLY

A. After sanding, check the proper location and fit of each part by assembling parts loosely, without gluing. Use the DETAIL VIEWS as a guide.

B. All parts for X-ACTO kits are made on precision milling machines. When adjustments are required, sand to fit.

Layout Sheet

Kit 40052

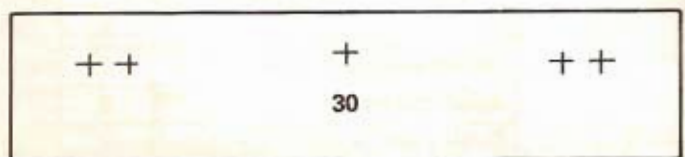
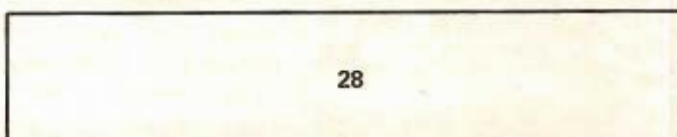
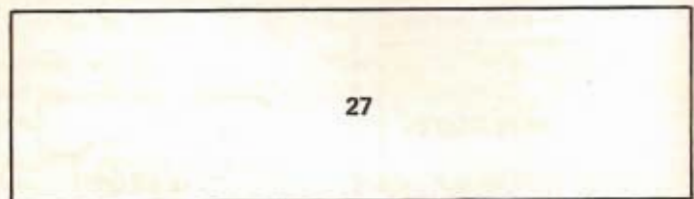
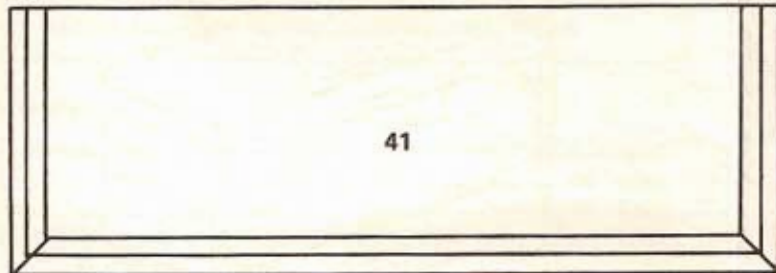
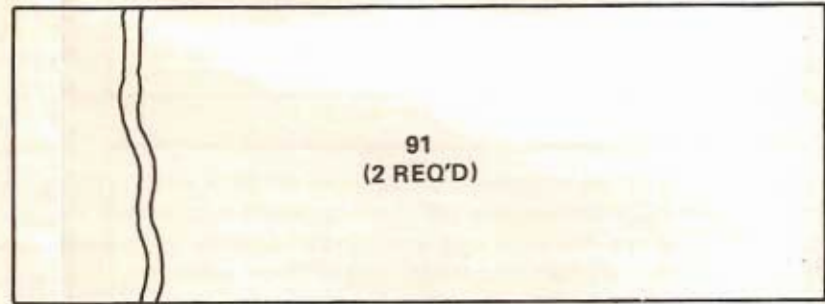
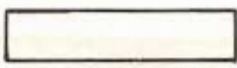
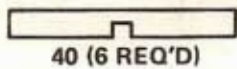
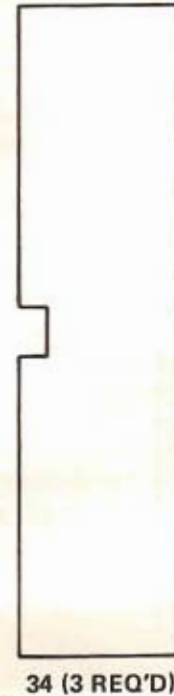
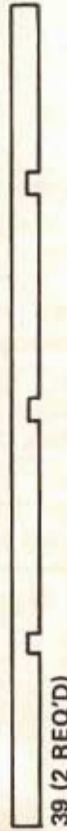
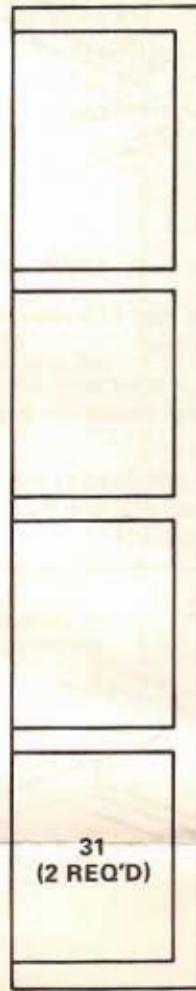
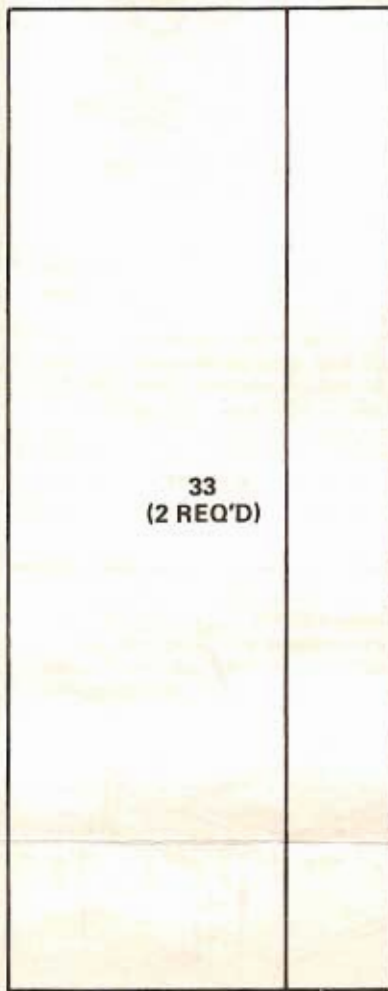

Detail Views

Kit 40052

Layout Sheet

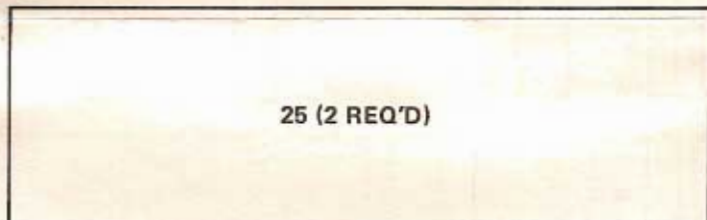
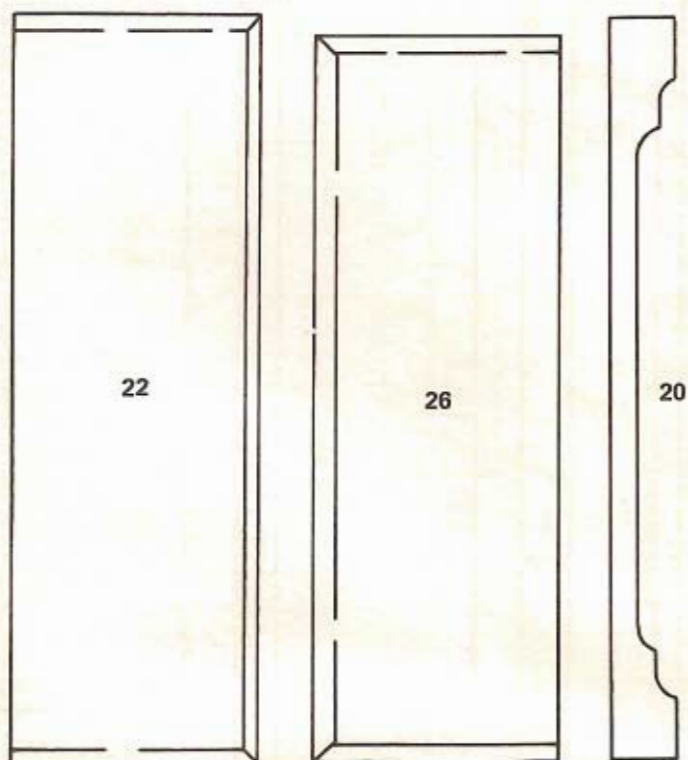

25 (2 REQ'D)

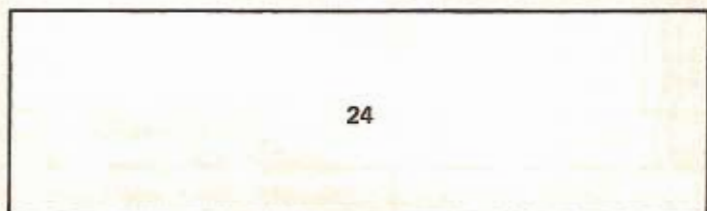

24



23 (2 REQ'D)

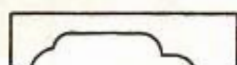

21 (2 REQ'D)

HARDWARE CHECK LIST

Hinge Pin	4
Small Escutcheon Plate	2
Small Handle Bail	2
Small Keyhole Plate	2
Keyhole Plate	1

Step 1

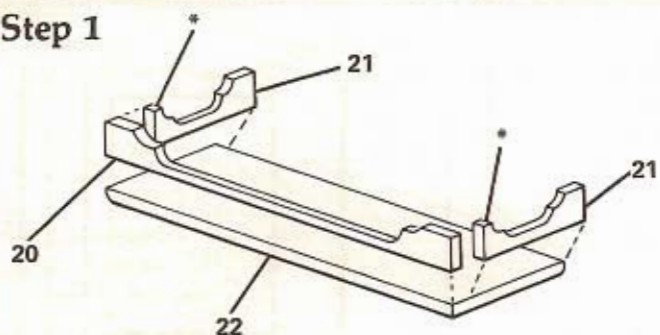

- Place base (22) with rounded edge down.
- Glue bracket trim (20) flush with front (rounded) edge of base (22).
- Glue side bracket trim (21) to (20) and (22) and flush with ends of base (22).

*One foot of the side bracket trim (21) is narrower than the other. The narrow part is glued to the front against (20).

Step 2

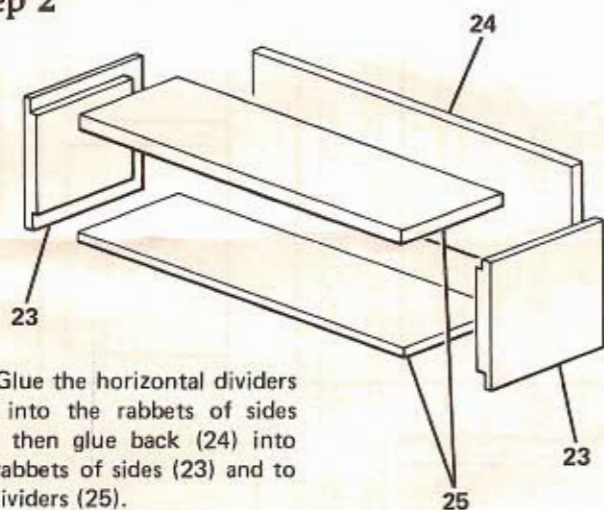

- Glue the horizontal dividers (25) into the rabbets of sides (23), then glue back (24) into the rabbets of sides (23) and to the dividers (25).
- Sand top and bottom of assembly flush if necessary.

Step 3

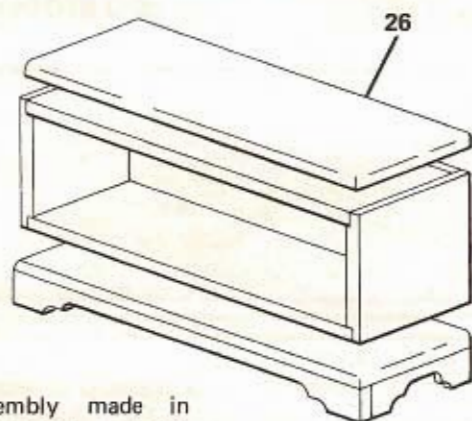

- Glue assembly made in Step 2 to the base made in Step 1, then add the base cap (26).
- Backs of all three should be sanded flush and assembly should be centered.

Detail Views

Kit 40052

Step 4

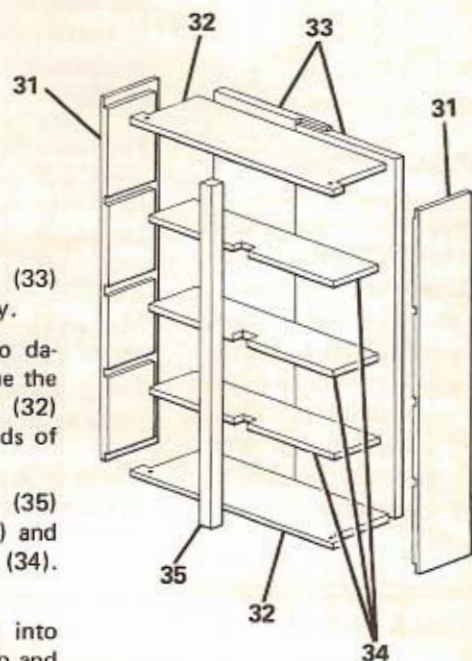

- Glue back pieces (33) together and set aside to dry.
- Glue shelves (34) into dados in sides (31) then glue the top and bottom shelves (32) into the rabbets at the ends of the sides (31).
- Sand center divider (35) to fit between shelves (32) and into notches of shelves (34). Glue into place.
- Glue back assembly into place, sand sides, back, top and bottom of assembly flush.

Step 6

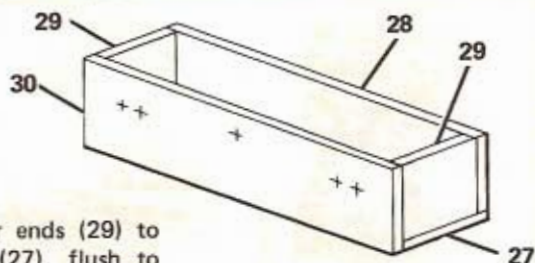

- Glue drawer ends (29) to drawer bottom (27), flush to ends and front edge.
- Glue back (28) to bottom (27), and ends (29).
- If entire drawer is to be stained, glue drawer front (30) on at this time. If inside of

drawer is to be left unfinished, finish front separately and then assemble.

- Drill holes for hardware using spacing shown on Layout Sheet.

Step 5

Alignment Pattern

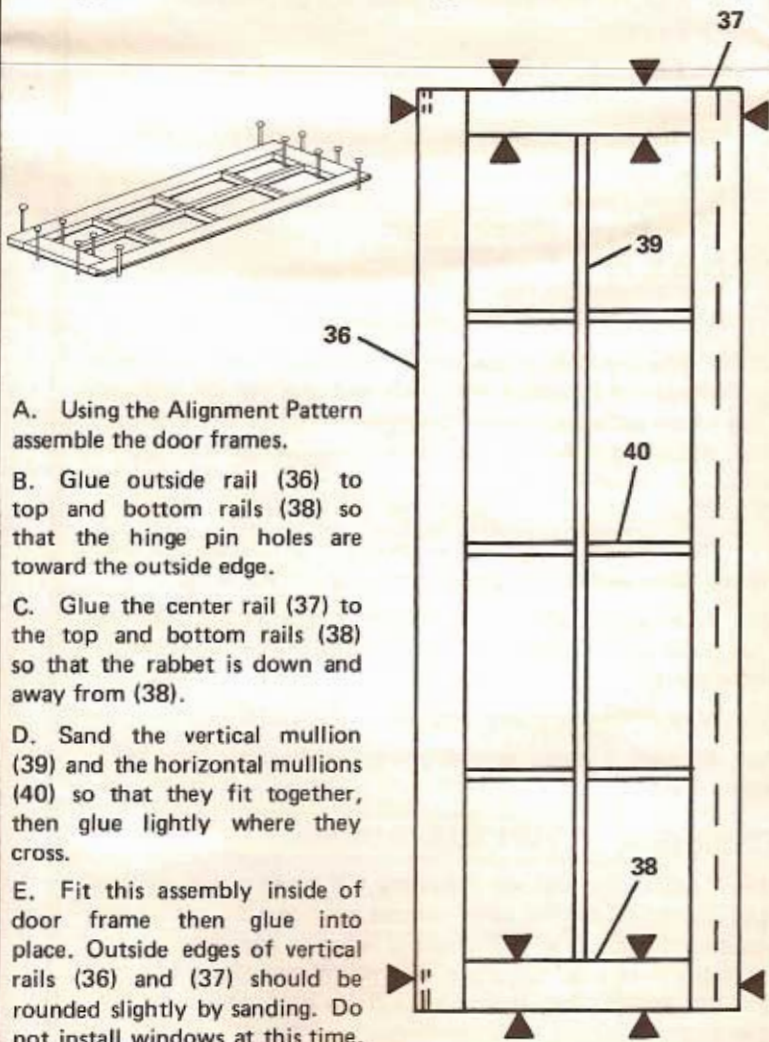

- Using the Alignment Pattern assemble the door frames.
- Glue outside rail (36) to top and bottom rails (38) so that the hinge pin holes are toward the outside edge.
- Glue the center rail (37) to the top and bottom rails (38) so that the rabbet is down and away from (38).
- Sand the vertical mullion (39) and the horizontal mullions (40) so that they fit together, then glue lightly where they cross.
- Fit this assembly inside of door frame then glue into place. Outside edges of vertical rails (36) and (37) should be rounded slightly by sanding. Do not install windows at this time.

Step 7

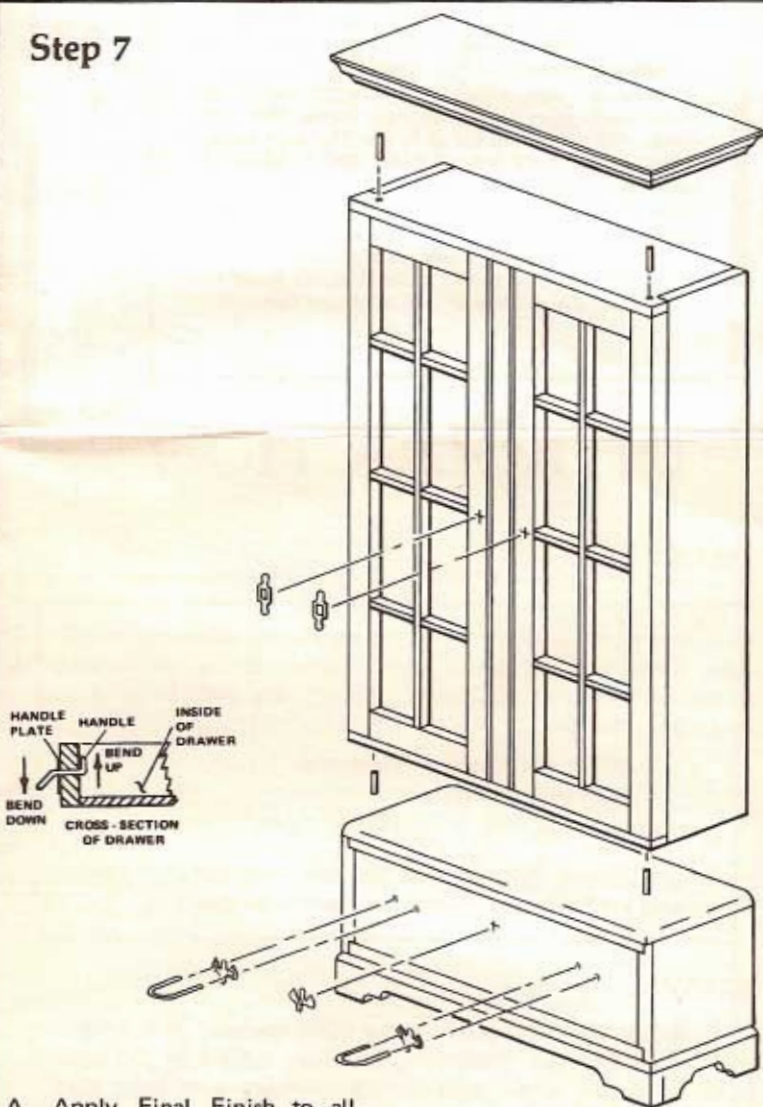

- Apply Final Finish to all individual parts and assemble at this time.
- Once finish is applied, assemble using a white glue that dries hard and clear.
- Glue windows (91) to the back of the doors.
- Glue keyhole plates to center rails as indicated.

- Install doors by inserting hinge pins as indicated.
- Glue base, shelf assembly and pediment together so that backs are flush and assemblies are centered.
- Install hardware and keyhole plate on drawer as indicated.