

COLLECTORS NO. 40081

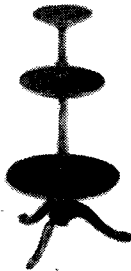

Dumb Waiter
Circa 1760-1775

This piece is typical of the many different styles of this type of furniture that were commonly used during the latter part of the 18th, and early part of the 19th Century. They were called dumb waiters, servers, tiered servers, and etagers.

Dumb waiters were primarily used in the dining room where they were used to hold the extra china and flatware to be used during the meal, and as the meal progressed, the various dishes that were to be served. The servants would place whatever was needed next upon it, and then serve it as required during the meal.

The dumb waiters were also used in other rooms, for more informal affairs, as a place to lay out light snacks, sweets, or drinks for guests.

The development of this piece of furniture was made possible by the improvement in design of the turning tools, or lathes, available to the cabinetmakers. Greater accuracy was needed to turn the columns and shelves for a dumb waiter than was needed to turn heavy table legs such as those that were used on earlier furniture. With the development of better tools, lighter pieces of furniture such as this became common.

ASSEMBLY AND FINISHING INSTRUCTIONS



AUTHENTIC REPRODUCTIONS IN MINIATURE

The X-ACTO® HOUSE OF MINIATURES COLLECTORS SERIES of furniture and accessories have all been carefully researched by specialists through major museum and library collections to assure the highest quality of authenticity in reproduction. Details are extraordinarily accurate to satisfy the most discriminating miniaturist.

All wood parts are machined to assure accurate and precise acceptance of each piece by another.

For a complete catalog of the X-ACTO® HOUSE OF MINIATURES furniture line and accessories, write to:
THE HOUSE OF MINIATURES
Customer Service - Catalog Dept.
80 Newbridge Road
Bergenfield, NJ 07621

INTRODUCTION

BEFORE STARTING

Identify and account for each part by placing it on the Layout Sheet (make sure the correct layout sheet is used when working on multi-kit Instruction Sheets). Should any parts be missing, send a post card to:

THE HOUSE OF MINIATURES
Customer Service - Parts Dept.
2000 Craftmark Center
Statesville, NC 28677-2000

Please print Name, Address, Part Number (Number from Layout Sheet) and Kit Name and Number on card when ordering.

SANDING

Before assembly, sand all the outer surfaces of individual parts with 220 grit sandpaper, or finer, sanded in the same direction as the wood grain until the surface is smooth. Take care not to round any edges or corners of the pieces. Finish sanding with 280 grit sandpaper.

PRE-ASSEMBLY

A. After sanding, check the proper location and fit of each part by assembling parts loosely, without gluing. Use the **DETAIL VIEWS** as a guide.

B. All parts for X-ACTO kits are made on precision

milling machines. When adjustments are required, sand to fit.

TOOLS AND MATERIALS

A. The following tools will be helpful in constructing this kit:

1. X-ACTO Professional Finishing Kit (or equivalent, see note)
2. 2" Sander, X-ACTO No. 7042

B. The following materials will be needed to construct this kit:

1. X-ACTO Tinted Glue (see note)
2. Sandpaper - 220 and 280 grit
3. Small Artist's Brush

NOTE: The X-ACTO tinted glue is matched to the finish used in the Professional Finishing Kit. This will produce the authentic finish of the period in which the original Furniture was produced. When not using X-ACTO glue follow manufacturer's directions.

GLUING

A. Glue should be applied in small amounts to surface being joined. When gluing dado joints apply glue to **dado only**.

B. To ensure a tight fit, squeeze excess glue out of the joints. Hold glued parts together with clamps, rubber bands or weights on the parts.

C. **Wipe off excess glue promptly.**

D. Be sure a glued assembly has dried thoroughly before adding parts.

FINISHING

The X-ACTO Professional Finishing Kit enables you to finish your furniture by the same process used by the professional furniture maker. The end result is what is important — there are easier methods, but none that will give the quality results that this process will. If you use a finish other than X-ACTO's, refer to the manufacturer's directions.

Layout Sheet

Kit 40081

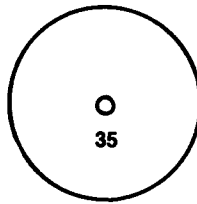
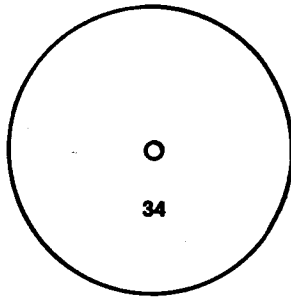
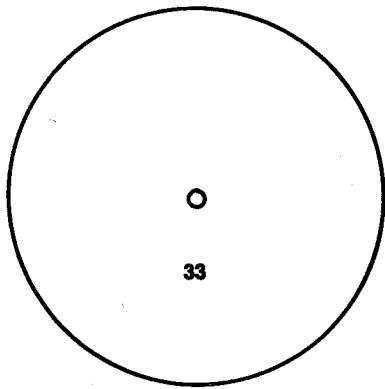

Detail Views

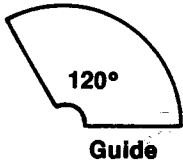
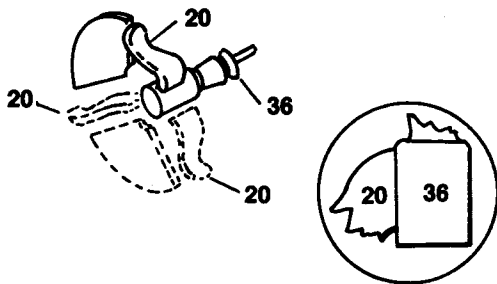

Step 1:

A. Glue one leg (20) to the pedestal (36) so that its top edge is at the curve at the top of the large lower portion of the turning. (Note: All of the legs are to be aligned in this manner.) Allow the glue to set firmly on this first leg before proceeding.

B. Cut out the 120° Guide and use it to align the other two legs. Allow the glue to set firmly and check that the pedestal assembly sets level. Sand the legs lightly if needed to level the pedestal.

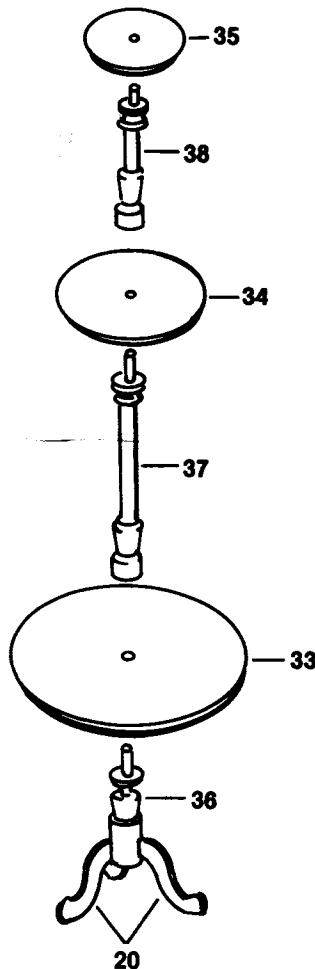

Step 2:

(NOTE: Do not rush this step. Level each shelf and align each column carefully, allowing the glue to set firmly each time.)

A. Install the lower shelf (33) on the pedestal. Level it and allow the glue to set. Glue the lower column (37) onto the dowel of the pedestal. The vase turning is at the lower end.

B. Glue the center shelf (34) and the upper column (38) onto the dowel of the lower column.

C. Glue the top shelf (35) to the dowel of the upper column. After the glue has set sand the end of the column dowel off flush with the upper shelf.

D. Apply the stain and final finish.