

COLLECTORS NO. 40001  
CLOSED CABINET TOP

## ASSEMBLY AND FINISHING INSTRUCTIONS

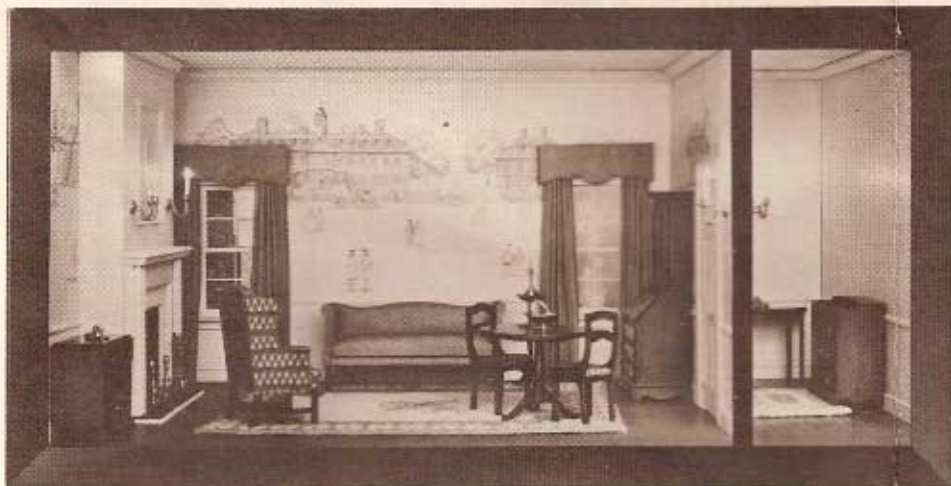

AUTHENTIC REPRODUCTIONS IN MINIATURE



The X-ACTO® House of Miniatures® Collectors Series of furniture and accessories have all been carefully researched by specialists through major museum and library collections to assure the highest quality of authenticity in reproduction. Details are extraordinarily accurate to satisfy the most discriminating miniaturist.

Every item in the line is an authentic reproduction in miniature of regular-size furniture created by master craftsmen during the Colonial period, precision scaled, one inch to one foot.

All wood parts are machined to assure accurate and precise acceptance of each piece by another.

The rooms illustrated have been completed using standard X-ACTO® HOUSE OF MINIATURES products. All individual components are available.

For a complete catalog of the X-ACTO® HOUSE OF MINIATURES furniture line and accessories, write to:

X-ACTO® THE HOUSE OF  
MINIATURES Dept. KIT  
45-35 Van Dam Street  
Long Island City, New York  
11101

Please include 50¢ for postage and handling.

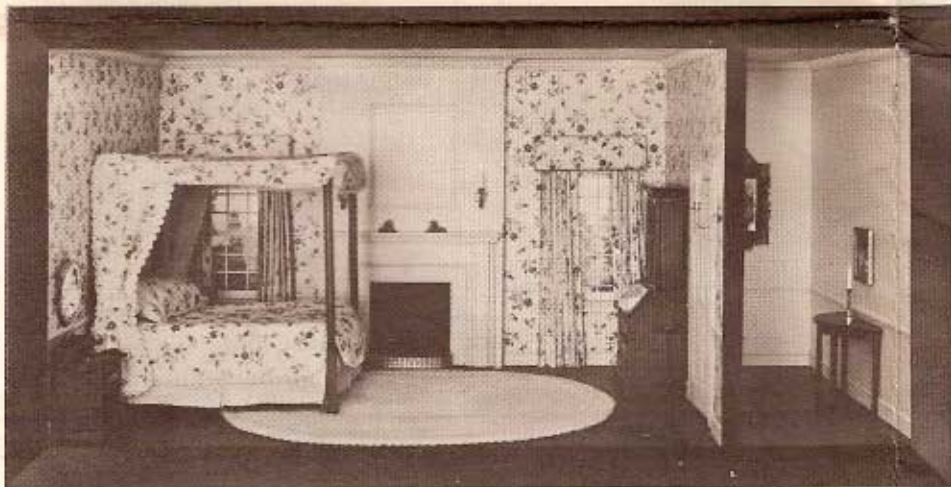

# X-ACTO®

# INTRODUCTION

## INSTRUCTIONS BEFORE STARTING

### before starting

A. Identify and account for each part by placing it on the **LAYOUT SHEET** (Page 2). This will indicate, at a glance, whether any parts are missing. **(See instructions at bottom of last sheet to order missing parts.)**

B. The **LAYOUT SHEET** contains a hardware check list. Use this to identify and account for all hardware that comes with the kit.

### sanding

**NOTE:** When using sandpaper, remember that the higher the grit number, the finer the finish.

A. One sanding method that has proved successful is the use of a sanding platform. Tape a sheet of sandpaper of the proper grit size to a hard flat surface such as a table top or wood block. Press down **lightly** and move the piece to be sanded **in the same direction** as the wood grain until the surface is smooth. **Take care not to round any edges or corners of the pieces.**

B. Before assembly, sand all the outer surfaces of individual parts with 220 grit sandpaper, or finer, paying particular attention to edges that will be exposed after assembly. After sanding each piece thoroughly, finish sanding with 400 grit sandpaper. Remember, your final stained finish will only be as smooth as the surface under it.

### hardware

A. All hardware to complete this kit is provided. Holes for the hinge pins have been pre-drilled. Installation holes for all other hardware must be made in accordance with the **ASSEMBLY** instructions that follow. Use the **DETAIL VIEWS** (Page 3) for hole locations.

B. Do not force knobs into holes in escutcheons. If the hole is too small, enlarge it slightly with a small knife or needle file.

C. Do not install brass hardware until final finishing has been done to avoid staining hardware.

### gluing

A. Glue should be applied in small amounts to both surfaces being joined. On end cuts, it may be necessary to apply a second coat of glue before joining the parts.

B. To ensure a tight fit, squeeze excess glue out of the joints by holding glued parts together with either clamps, rubber bands or by placing weights on the parts.

C. Wipe off excess glue promptly with a damp cloth.

D. Be sure a glued assembly has dried thoroughly before adding any more parts.

### tools and materials

A. The following tools **will be helpful** in constructing this kit:

1. Knife, X-ACTO No. 1, with Blade, X-ACTO No. 11
2. Tweezer, X-ACTO No. 36
3. One inch sander, X-ACTO No. 41
4. Two-inch Sander, X-ACTO No. 42
5. Large Clamp, X-ACTO No. 4004
6. Small Clamp, X-ACTO No. 4003
7. Swiss Needle File Set, X-ACTO No. 60S
8. End Snip Pliers, X-ACTO No. 1510, or Diagonal Cutting Pliers, X-ACTO No. 1505
9. Professional Finishing Kit, X-ACTO No. 43801
10. Power Sprayer, X-ACTO No. 43561

B. The following materials **will be needed** to construct this kit:

1. Straight pins or artist's push pins
2. Rubber bands
3. Waxed paper
4. Sandpaper - 220, 320 and 400 grit
5. Steel wool - Grade 000
6. Masking tape
7. Wood stain of your choice. **(See Note)**
8. Glaze stain of your choice. **(See Note)**
9. Lacquer or varnish of your choice. **(See Note)**
10. White glue, or any good wood glue. **(See Note)**
11. Sealer **(See Note)**
12. Small Artist's Brush

**NOTE:** The X-ACTO No. 43801 Professional Finishing Kit will produce the authentic Mahogany finish of the period in which the original furniture was produced. Base stain, glaze stain, lacquer or varnish, sealer and glue are required only if the X-ACTO Professional Finishing Kit is not used.

### pre-assembly

A. After sanding, check the proper location and fit of each part by assembling parts loosely, without gluing. Use the **DETAIL VIEWS** (Page 3) as a guide.

B. Parts can be held together to check proper fit with rubber bands or masking tape.

C. All parts for X-ACTO kits are made on precision milling machines, using rabbet and dado joints. Parts will fit together snugly with very little adjustments required. When adjustments are required, sand or file to fit.

# LAYOUT SHEET

21

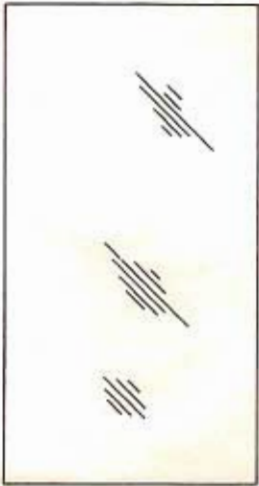

CLEAR PLASTIC

21



CLEAR PLASTIC

35

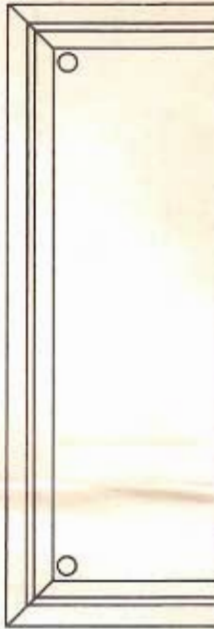

38



39

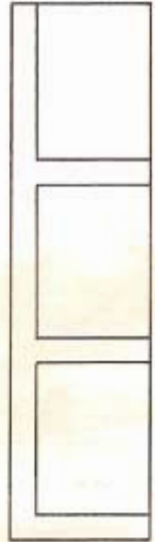

36

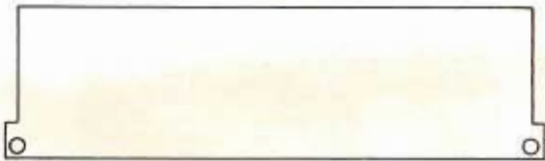

81



81



17

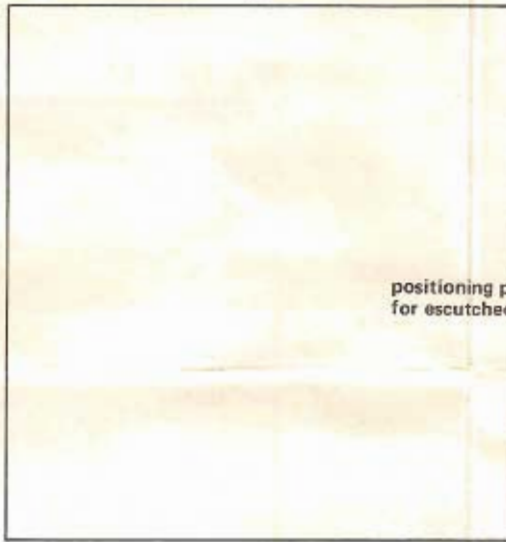

positioning points  
for escutcheon

42

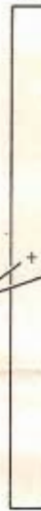

42



HOLE IN ENDS

43



43



HOLE IN ENDS

40



40



41

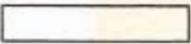

41

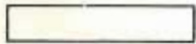

## HARDWARE CHECK LIST

DESCRIPTION	VISUAL DESCRIPTION	QTY
KNOB		2
ESCUTCHEON		2
HINGE PIN		4

# DETAIL VIEWS

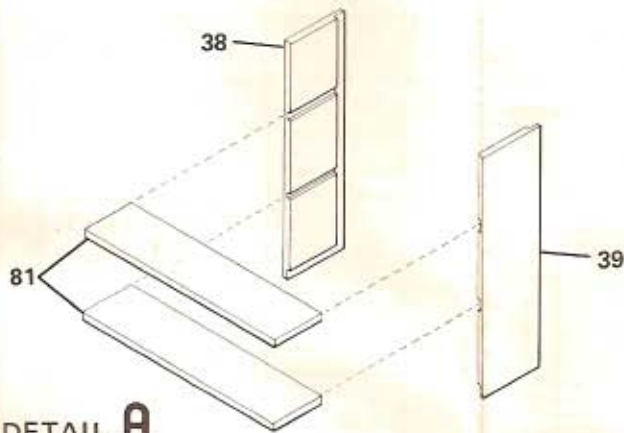

DETAIL A

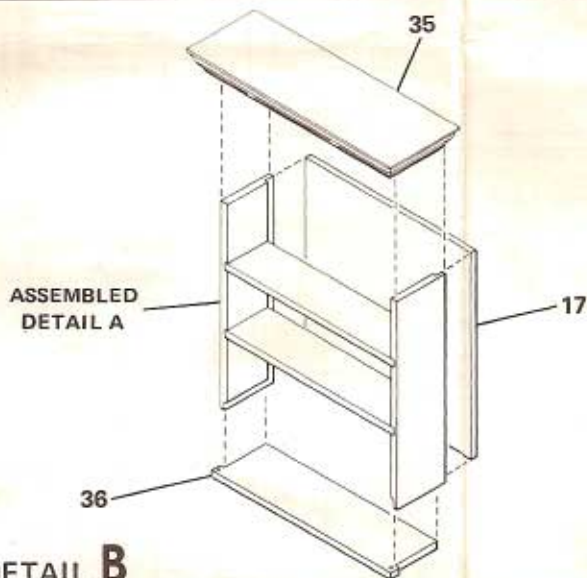

DETAIL B

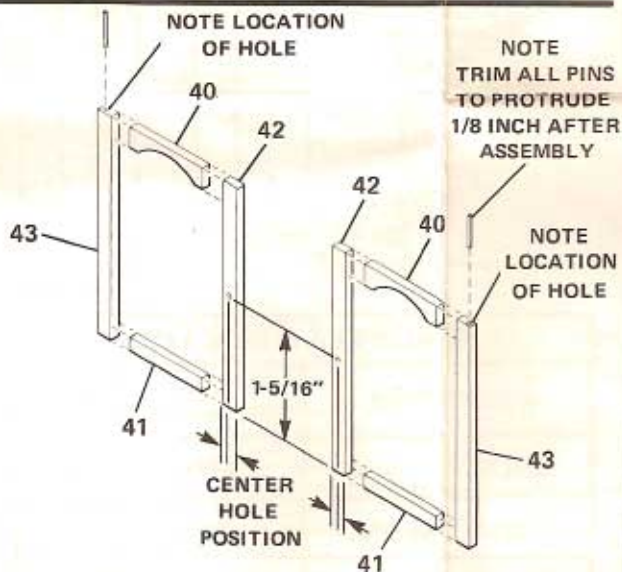

DETAIL C

NOTE  
REMEMBER TO FINISH  
BEFORE FINAL ASSEMBLY

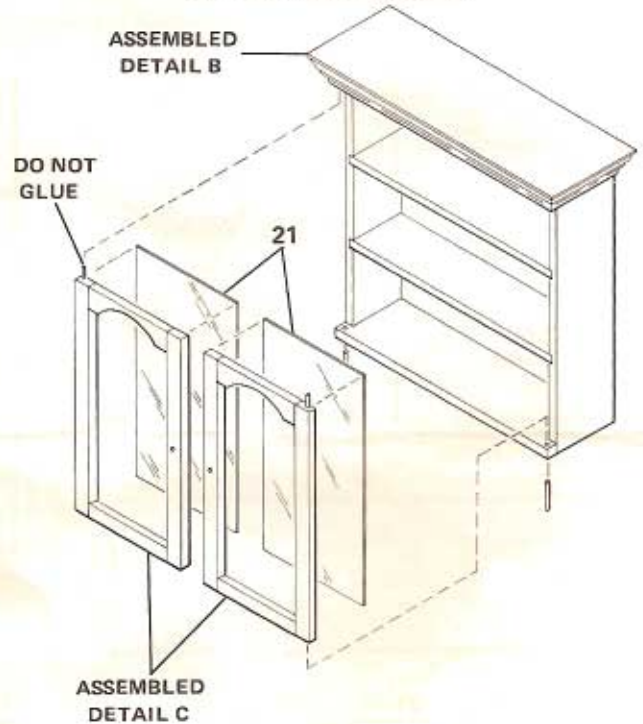

DETAIL D

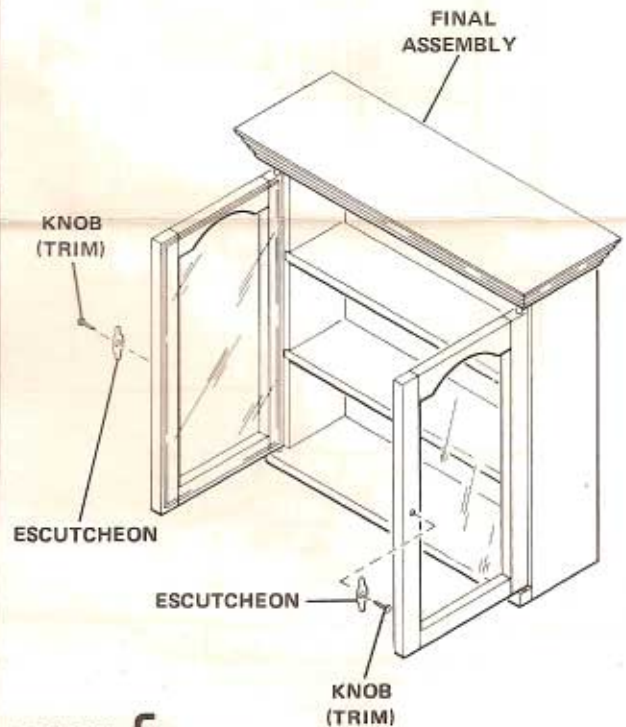

DETAIL E

# ASSEMBLY

A. Before starting to assemble your kit, study all illustrations and instructions carefully. Be certain you understand each step before proceeding to the next one.

B. Follow the sequence of steps in the order they are presented. **Do not** skip steps or take any short cuts.

C. Refer to **ALIGNMENT** (page 5) for patterns to be used to align the frame and secure the doors for gluing. When gluing parts together, use a flat toothpick or similar tool to apply a small amount of glue to the parts to be joined. Remove any excess glue promptly with a damp cloth. **Remember to let each glued assembly dry thoroughly before adding the next part.**

D. The Professional Finishing Kit, X-ACTO No. 43801, will produce the authentic Mahogany finish of this period and contains a **matching tinted glue**, which is recommended for assembly of this kit. The **tinted glue** is of furniture grade quality, equivalent to that used by professional cabinet makers and its use will avoid the appearance of a glue line at each joint.

E. Begin assembly of the **frame** (see **DETAIL A**, page 3) as follows:

1. Glue two shelves (part no. 81) into grooves in sides (part no.'s 38 and 39). Align the parts face down on **pattern 1** (see **ALIGNMENT**, page 5).

2. Press the back piece (part no. 17) into place, but **do not glue**. This will help align the frames and keep parts in position.

3. Use clamps, or several rubber bands, to hold parts in place until glue sets. (Follow the instructions for the glue being used for the proper setting time.)

F. Complete assembly of frame (see **DETAIL B**, page 3) as follows:

1. Glue back (part no. 17), top (part no. 35), and bottom (part no. 36) to assembled Detail A. Make sure that the rear edge of top is flush with rear edges of sides and back and that top is centered over sides.

2. Secure parts in position with clamps or rubber bands and put assembly aside until glue has set.

G. Assemble **doors** (see **DETAIL C**, page 3) as follows:

1. Glue together sides (part no.'s 42 and 43), top (part no. 40) and bottom (part no. 41). Align parts using **pattern 2** (see **ALIGNMENT**, page 5) and pin parts in position until glue has set. Note the location of hinge pin holes in part no. 43. The holes should be closer to the outside edge of the door,

2. After door frames have been assembled, insert two hinge pins in the holes in top of each door, as shown. Push each pin into hole as far as it will go. Then trim the ends with end snip pliers or diagonal cutting pliers so that they protrude 1/8 inch above door frame. **Do not** install pins in the **lower** holes of the doors.

3. Using a strong pin or artist's push pin, make a hole in the center of each inside door frame, 1-5/16 inch from the lower edge. Brass hardware will be installed in these holes as a final step.

H. Before proceeding with the final assembly of your furniture, the assembled frame (**DETAIL B**, page 3) and doors (**DETAIL C**, page 3) must be stained. **Refer to FINAL FINISHING, and proceed through paragraph C before continuing on to paragraph I of ASSEMBLY.**

I. After staining has been completed and assemblies have been allowed to dry thoroughly, proceed as follows (see **DETAIL D**, page 3).

1. Glue windows (part no. 21) to **rear** of doors. Use white glue, which dries to a clear film, so that glue will not be apparent through window. Allow glue to set.

2. Press (**do not glue**) hinge pin at the top of each door into holes under the top (part no. 35).

3. Install door by angling door and inserting top hinge pin in hole in top (part no. 35). Position door over through-hole in bottom (part no. 36) and insert lower hinge pin from the bottom. Press in pin as far as it will go, then cut off excess. Repeat procedure for second door.

**4. Continue with FINAL FINISHING starting with paragraph D.**

J. Install brass hardware on doors (see **DETAIL E**, page 3) as follows:

1. Apply a small amount of glue on the back of escutcheon.

2. Insert knob through hole in escutcheon and press into door frame as shown. Remember that pointed tip of knob must be trimmed off before inserting into door frame.

3. Repeat procedure for other door.

K. You have now completed assembly of your furniture. The completed piece should look like that shown in **DETAIL E** (page 3). The doors should meet evenly at the center and should swing freely on the hinge pins, without binding.

## FINAL FINISHING

In order to ensure that your piece is stained and highlighted in the tones of the period in which the original furniture was produced, we recommend that X-ACTO Professional Finishing Kit, No. 43801 be used. The following method is used by professional furniture makers, and, if done properly, will result in museum quality.

A. After assembly is completed and the glue has set, **lightly** sand all joint areas to remove excess glue, using 220 grit sandpaper or finer. Moisten a cloth slightly and rub the dampened cloth over the entire wood surface to raise the grain. When all signs of moisture have gone from the wood, resand using a 320 to 400 grit sandpaper.

B. With a small brush, apply a light sealer coat to all edges and end grains. Use the side of the brush rather than the tip, in a wiping motion, so that the sealer does not touch other surfaces. Sealing the edge and end grains will prevent the subsequent stains from penetrating these areas as deeply, resulting in a more uniform stain on all parts.

**NOTE:** If the X-ACTO Finishing Kit (which contains a high quality sealer) is not used, thinned varnish or lacquer can be used for this purpose.

C. To match the color of furniture of this period apply **X-ACTO Base Stain** or mahogany or cherry stain of your choice with a brush or cloth over the entire wood surface. Immediately wipe off all excess stain leaving an even color on the surface. Allow to dry. (Continue with **ASSEMBLY** starting with paragraph I).

D. Apply a thin coat of **X-ACTO Sealer** or any commercial wood sealer over the base stain. This can be applied with either a brush or with the **X-ACTO Power Sprayer**. Make sure there are no drip marks present. Allow the sealer to dry for at least 6 hours.

X-ACTO POWER SPRAYER No. 43561 can be used to apply sealer, top coat, and paints for outstanding results. This spray ensures application of an even coat, especially on intricate and flat surfaces, and it is highly recommended for finishing your furniture.

E. Lightly go over all surfaces with Grade 000 steel wool until they are smooth to the touch.

F. "**Highlighting**" is a technique of creating light and dark areas and is accomplished by applying the **X-ACTO Glaze Stain** or any commercial glaze stain of your choice (Van Dyck Brown is the color recommended) and then toning by rubbing off the glaze in certain areas, exposing the base stain. In order to "highlight", apply a dark glaze with a brush or rag over the entire piece of furniture. As soon as you have applied this glaze, wipe off the excess. Blend tones of base color and glaze stain by using a piece of soft cloth. There should never be a sharp line of dark color to light color, but rather a smooth blending effect. Lighten the middle surface of the wood, but do not lighten the entire surface. The "**highlighting**" technique will produce museum quality miniature furniture.

G. After the glaze stain has dried for 24 hours, thoroughly and briskly wipe all surfaces with a clean cloth until you are satisfied with the appearance. Apply the **X-ACTO Top Coat** or a coat of lacquer or varnish, with a brush, an airbrush, or with the **X-ACTO Power Sprayer**. Apply two or more top coats with light buffing between coats using Grade 000 steel wool. After each steel wool rubbing make sure all steel wool "dust" is removed thoroughly. (Continue with **ASSEMBLY** starting with paragraph J).

# ALIGNMENT

A. Tape this sheet to a smooth, flat surface, one that pins can be pushed into. Then tape sheet of waxed paper to the pattern so that any excess glue at the joint will not stick to the pattern, making it difficult to remove the completed assembly.

B. Use the alignment patterns shown here to position the indicated parts properly and to hold them in alignment while drying. The arrowheads show the points to insert the straight pins to properly secure the parts.

## alignment patterns

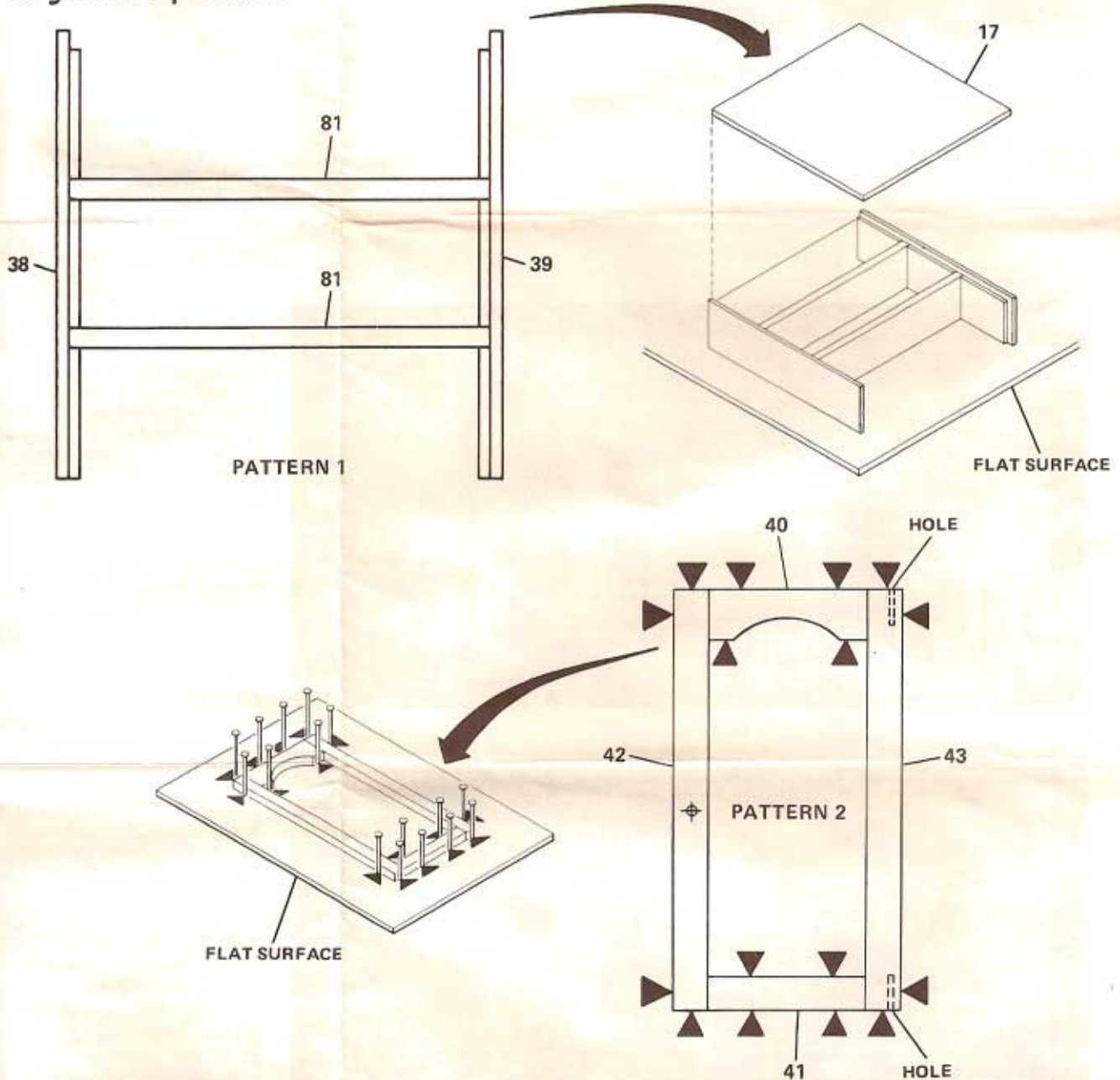

Every effort has been made to insure the completeness of this KIT—however, should any parts be missing, write directly to:  
 X-ACTO/THE HOUSE OF MINIATURES  
 45-35 Van Dam Street  
 Long Island City, N.Y. 11101



AUTHENTIC REPRODUCTIONS IN MINIATURE

When ordering missing parts, please Print your name and address plainly. State the missing PART NO. (See LAYOUT SHEET, page 2), KIT NO. 40001 and the Kit Name, "CLOSED CABINET TOP".