

COLLECTORS NO. 40083



Queen Anne
Armchair
Circa 1740-1760

This armchair was constructed during the latter part of the Queen Anne period and is typical of the style of chair that has survived and is still very popular today. At that point in time, the cabinetmaker's skills had progressed to where a light and delicate chair such as this could be produced. The turned spreaders used on earlier styles have been eliminated, and the full impact of the graceful cabriole legs can be appreciated.

The splat is vase shaped, and the top rail is called a "yoke" shape. The arms have graceful, yet strong lines. Their shape lends to the lightness of the total chair appearance.

The design of this chair has a definite American look, but like all of the chairs of the Colonial period, is based upon English designs. Out of all the Colonial chairs, only the Boston Rocker does not have an English, or European counterpart.

The English built chairs of this style were constructed largely of mahogany, but the American versions were also made of several of the native hardwoods.

ASSEMBLY AND FINISHING INSTRUCTIONS



AUTHENTIC REPRODUCTIONS IN MINIATURE

The X-ACTO® HOUSE OF MINIATURES COLLECTORS SERIES of furniture and accessories have all been carefully researched by specialists through major museum and library collections to assure the highest quality of authenticity in reproduction. Details are extraordinarily accurate to satisfy the most discriminating miniaturist.

All wood parts are machined to assure accurate and precise acceptance of each piece by another.

For a complete catalog of the X-ACTO® HOUSE OF MINIATURES furniture line and accessories, write to:
THE HOUSE OF MINIATURES
Customer Service - Catalog Dept.
80 Newbridge Road
Bergenfield, NJ 07621

milling machines. When adjustments are required, sand to fit.

TOOLS AND MATERIALS

A. The following tools will be helpful in constructing this kit:

1. X-ACTO Professional Finishing Kit (or equivalent, see note)
2. Small Plastic Clamps, X-ACTO No. 7003
3. 2" Sander, X-ACTO No. 7042

B. The following materials will be needed to construct this kit:

1. X-ACTO Tinted Glue (see note)
2. Sandpaper - 220 and 280 grit
3. Small Artist's Brush

NOTE: The X-ACTO tinted glue is matched to the finish used in the Professional Finishing Kit. This will produce the authentic finish of the period in which the original Furniture was produced. When not using X-ACTO glue follow manufacturer's directions.

GLUING

A. Glue should be applied in small amounts to surface being joined. When gluing dado joints apply glue to dado only.

B. To ensure a tight fit, squeeze excess glue out of the joints. Hold glued parts together with clamps, rubber bands or weights on the parts.

C. Wipe off excess glue promptly.

D. Be sure a glued assembly has dried thoroughly before adding parts.

FINISHING

The X-ACTO Professional Finishing Kit enables you to finish your furniture by the same process used by the professional furniture maker. The end result is what is important — there are easier methods, but none that will give the quality results that this process will. If you use a finish other than X-ACTO's, refer to the manufacturer's directions.

INTRODUCTION

BEFORE STARTING

Identify and account for each part by placing it on the Layout Sheet (make sure the correct layout sheet is used when working on multi-kit Instruction Sheets). Should any parts be missing, send a post card to:

THE HOUSE OF MINIATURES
Customer Service - Parts Dept.
2000 Craftmark Center
Statesville, NC 28677-2000

Please print Name, Address, Part Number (Number from Layout Sheet) and Kit Name and Number on card when ordering.

SANDING

Before assembly, sand all the outer surfaces of individual parts with 220 grit sandpaper, or finer, sanded in the same direction as the wood grain until the surface is smooth. Take care not to round any edges or corners of the pieces. Finish sanding with 280 grit sandpaper.

PRE-ASSEMBLY

A. After sanding, check the proper location and fit of each part by assembling parts loosely, without gluing. Use the DETAIL VIEWS as a guide.

B. All parts for X-ACTO kits are made on precision

Layout Sheet

Kit 40083

Note: Quantities shown on this Layout Sheet are for 2 chairs.

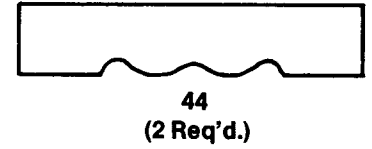
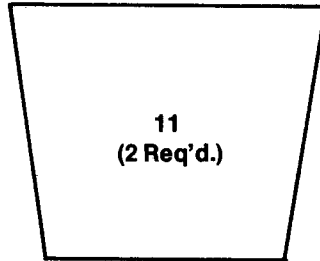
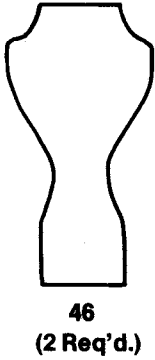
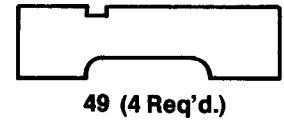
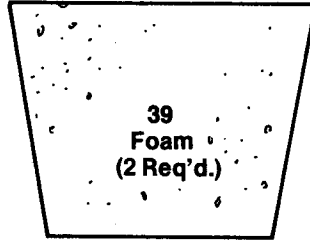
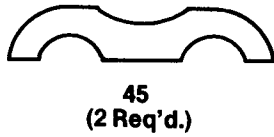

40 (8 Req'd.)

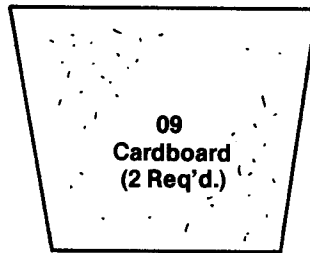
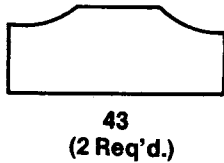

MATERIAL - 15 (not shown)

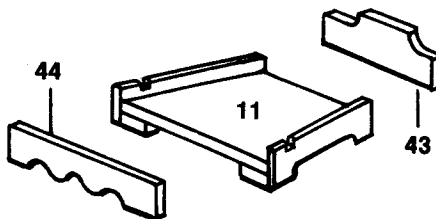
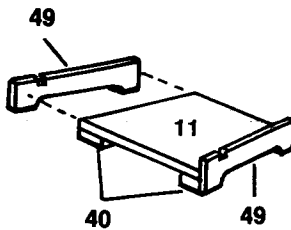
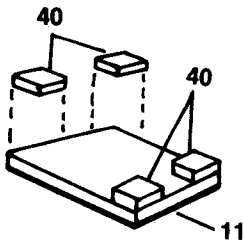

Step 1:

A. Glue the four corner blocks (40) to the four corners of the seat (11). Line up the angle cut on the blocks with the angle of the seat sides.

B. Glue the sides (49) to the sides of the seat. They should be flush with the bottom of the corner blocks and the inside back edge should be flush with the rear edge of the seat. Allow the glue to set.

C. Sand the front and rear edges of the seat sides flush with the front and rear of the seat. Glue on the seat front (44) flush with the bottom of the corner blocks. Sand the ends flush with the sides and round slightly.

D. Glue on the seat back (43) so that it is centered and is flush with the bottom of the corner blocks. A notch the width of the rear legs will be formed in the rear corners.

Detail Views

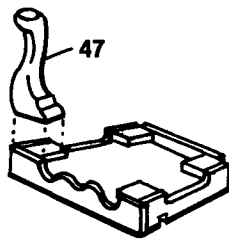
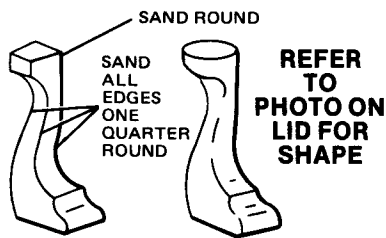

Step 2:

- Shape the legs (47) as shown in the detail drawing. Refer to the picture on the history sheet or the box lid as a guide.
- Glue the legs (47) to the bottom of the seat. The front edge of the top of the leg should be aligned with the front of the seat. On the side, only the front corner will line up. After the glue has set, round off the leg top on the side so that it blends into the angle of the seat side.

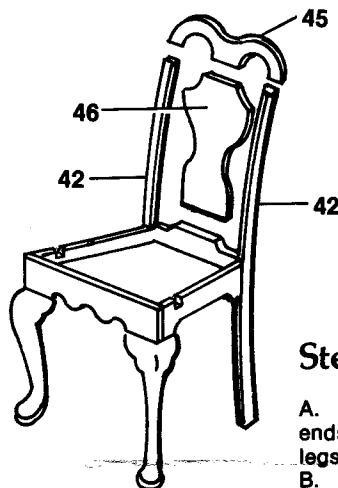

Step 3:

- Glue the top rail (45) to the top ends of the two rear legs (42). The legs should be parallel.
- Glue the top of the splat (46) to the bottom of the top rail so that it is centered. Then glue the rear legs (42) into the notches at the back corners of the seat and glue the bottom of the splat to the center of the seat back (43).
- Check the alignment of the chair back and legs and allow the glue to set up hard. Check that the chair sets level. If not, sand the bottoms of the rear legs lightly as needed.

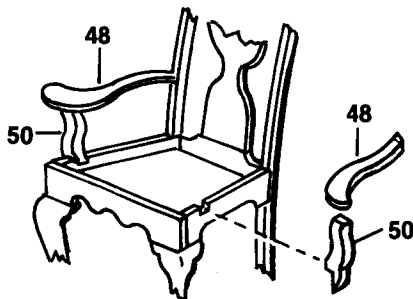

Step 4:

- (Note: Sand and shape all edges, except for those that join to another piece, of the arms and arm supports.) Glue the arm supports (50) into the notches of the seat sides. They should be perpendicular to the seat sides and be lined up with each other.
- Glue the arms (48) on to the arm supports so that they are centered left-to-right and to the rear legs so that they are parallel to the seat sides and lined up with each other.
- After the glue has set, sand the rear sides of the arms so that they blend in with the rear legs where they join.

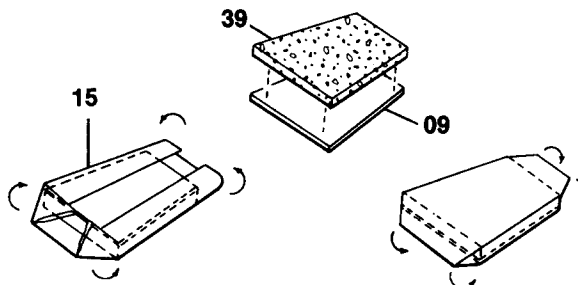

Step 5:

- Glue the cushion (39) to the base (09) with white glue. Cut material (15) into two equal pieces.
- Place the cushion, foam side down, on the material (15). Fold the material over the sides and glue into place.
- Tuck each corner under. Fold the front and rear of the fabric under and glue into place.
- After the glue has hardened, trim off any excess material with a sharp knife.
- Apply the stain and final finish to the chair. When it has dried, glue the cushion into place.

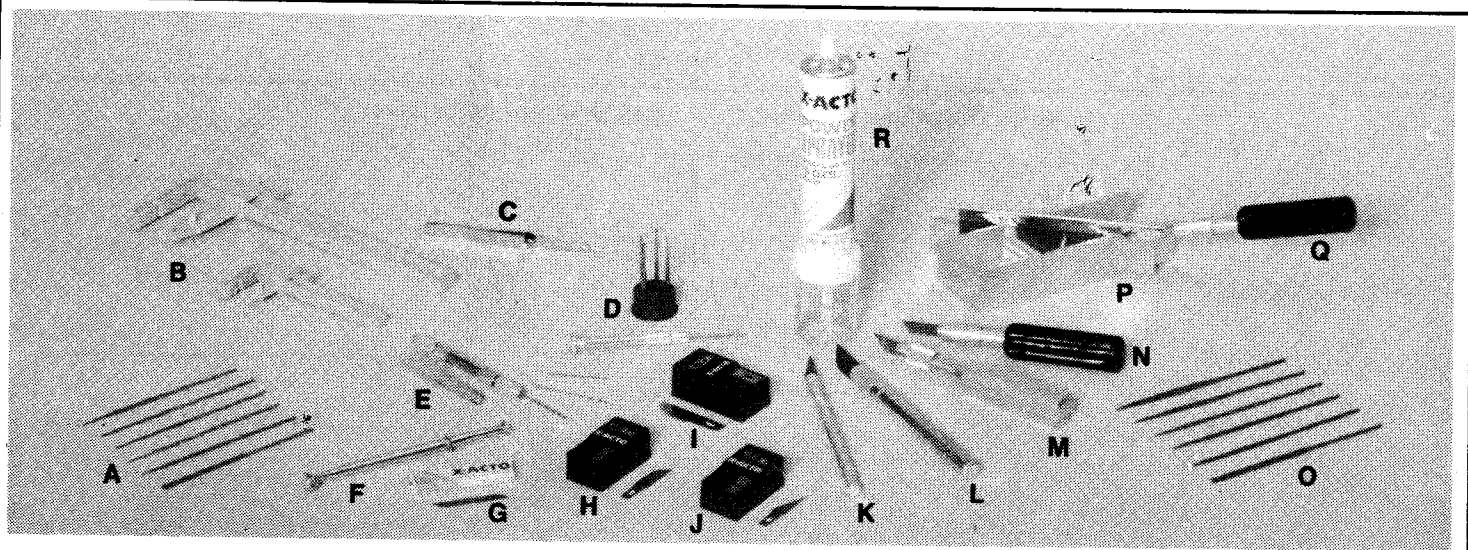

A. MINIATURE FILE SET

6 miniature needle files. 3 1/8" long. For intricate filing. Vinyl storage pouch. No. 7365

B. PLASTIC CLAMPS

Light duty plastic clamps for delicate work. Notched jaw allows grip of round parts. Smooth face prevents damage to workpiece.

Small plastic clamp. 3/4" opening with 1" throat depth. 2 per card: No. 7003

Large plastic clamp. 7/8" opening with 2 1/16" throat depth. 2 per card: No. 7004

C. SELF-CLOSING POINTED TWEEZER

Self-closing serrated points. Nickel-plated steel. 6 1/2." Carded: No. 7337

D. SCREWDRIVER WITH INTERCHANGEABLE BLADES

Aluminum handle and chuck and 5 steel screwdriver blades sizes .040" through .100." Notched shank for greater torque. Storage base. Carded: No. 7070

E. PIN VISE SET

Includes double-ended pin vise, vise bit guard and 3 assorted drill bits. Carded: No. 7144

F. PARTPICKER

For small hard-to-handle pieces. Smooth one-handed action. Carded: No. 7380

G. No. 13 BLADE

Precision saw cutting. 5 blades. Carded: No. 213

H. No. 10 BLADE

For fine general cutting, carving, correcting stencils. Safety dispenser of 10 blades. Carded: No. 410

I. No. 22 BLADE

General shaping, whittling, trimming, removing excess flashing. Safety dispenser of 10 blade. Carded: No. 422

J. No. 11 BLADE

Extremely sharp point for fine angle cutting and stripping. Safety dispenser of 10 blades. Carded: No. 411

K. No. 1 KNIFE

Aluminum handle 4 7/8" long with No. 11 blade. Carded: No. 3201

L. No. 2 KNIFE

Aluminum handle 5" long with No. 22 blade. Carded: No. 3202

M. No. 6 KNIFE

Aluminum handle 4 3/4" long with No. 24 blade. Carded: No. 3206

N. No. 5 KNIFE

Plastic handle with metal blade lock, 4 1/4" long with No. 19 blade. Carded: No. 3205

O. MINIATURE NEEDLE RASPS

6 assorted rasps. For rough shaping of wood or plastic. 4 3/4" long. Vinyl storage pouch. No. 7366

P. MITRE BOX

Aluminum 3/4" x 1 3/4" capacity. 6" long. With two 45° and one 90° cutting slots. Carded: No. 7533

Q. EXTRA-FINE RAZOR SAW

1 1/4" deep with cutting edge 5 1/2" long and 54 teeth per inch for extra fine precision. For use with No. 7533 mitre box. Carded: No. 7535

R. POWER SPRAYER

Push-button action sprays evenly. Includes a one ounce jar and propellant to spray on intricate or flat surfaces up to 16 ounces of liquid materials. Carded: No. 43561

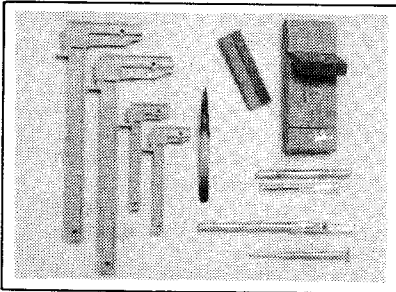

MINIATURIST'S TOOL SET

Basic tools for assembling miniatures, models and working with small parts. 4 clamps, tweezer, pin vise with 3 bits, 2 sanders, screwdriver and No. 1 Knife in fitted tray. No. 43910

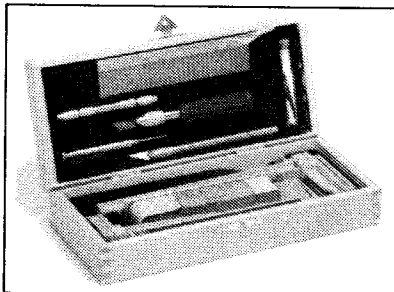

DELUXE MINIATURIST'S TOOL CHEST

Fitted wooden chest contains precision tools for assembling miniatures, models and working with small parts: razor saw blade, mitre box, 4 clamps, pin vise and 3 bits, Nos. 1 and 5 Knives, sanders and screwdriver. Boxed: No. 43911