

## COLLECTORS NO. 40066



### Chippendale Chest of Drawers

*Circa 1760-1780*

The antique that this miniature was adapted from was crafted in Rhode Island about the time of the Revolutionary War. The

outside was of curly maple and the interior was lined with chestnut. It was lightly stained and over these many years has developed a warm amber patina.

The graduated depth drawers and the simulated three drawers on top make it appear to be a larger piece of furniture than it actually is, and adds to its charm.

Chest of Drawers evolved from storage, or blanket chests. Drawers were added to these simple hinged lid chests and they grew taller. Eventually the chest top was eliminated and they became literally a chest of drawers.

Designs of these chests were as varied as any piece of furniture and they were built of all types of wood depending upon what native woods were available. The addition of burl, or exotic woods was the most common decorative device used by the cabinetmaker. The large front area of wood was relieved by brass drawer pulls and keyhole plates.

A large number of the chest drawers were made to satisfy the storage needs of the Colonists and as a result many survived for us to enjoy today.



AUTHENTIC REPRODUCTIONS IN MINIATURE

The X-ACTO® House of Miniatures Collectors Series® of furniture and accessories have all been carefully researched by specialists through major museum and library collections to assure the highest quality of authenticity in reproduction. Details are extraordinarily accurate to satisfy the most discriminating miniaturist.

All wood parts are machined to assure accurate and precise acceptance of each piece by another.

For a complete catalog of the X-ACTO® HOUSE OF MINIATURES furniture line and accessories, write to:

X-ACTO® THE HOUSE OF MINIATURES Dept. KIT  
45-35 Van Dam Street  
Long Island City,  
New York 11101

*Please include \$2.00 for postage and handling.*

## INTRODUCTION

### BEFORE STARTING

Identify and account for each part by placing it on the Layout Sheet (make sure the correct layout sheet is used when working on multi-kit Instruction Sheets). Should any parts be missing, send a post card to:

X-ACTO/The House of Miniatures  
45-35 Van Dam Street  
Long Island City, N.Y. 11101

Please print Name, Address, Part Number (Number from Layout Sheet) and Kit Name and Number on card when ordering.

### TOOLS AND MATERIALS

A. The following tools will be helpful in constructing this kit:

1. X-ACTO Two-inch Sander No. 7042
2. X-ACTO Large Clamp No. 7004
3. X-ACTO Pin Vise Set No. 7144
4. X-ACTO Professional Finishing Kit (or equivalent, see note)
5. X-ACTO Pliers No. 7504

B. The following materials will be needed to construct this kit:

1. X-ACTO Tinted Glue (see note)
2. Sandpaper - 220 and 280 grit
3. White glue (or equivalent)
4. Small Artist's Brush

**NOTE:** The X-ACTO tinted glue is matched to the finish used in the Professional Finishing Kit. This will produce the authentic finish of the period in which the original Furniture was produced. When not using X-ACTO glue follow manufacturer's directions.

### GLUING

A. Glue should be applied in small amounts to surface being joined. When gluing dado joints apply glue to dado only.

B. To ensure a tight fit, squeeze excess glue out of the joints. Hold glued parts together with clamps, rubber bands or weights on the parts.

C. Wipe off excess glue promptly.

D. Be sure a glued assembly has dried thoroughly before adding parts.

### FINISHING

The X-ACTO Professional Finishing Kit enables you to finish your furniture by the same process used by the professional furniture maker. The end result is what is important — there are easier methods, but none that will give the quality results that this process will. If you use a finish other than X-ACTO's, refer to the manufacturer's directions.

### SANDING

Before assembly, sand all the outer surfaces of individual parts with 220 grit sandpaper, or finer, sanded in the same direction as the wood grain until the surface is smooth. Take care not to round any edges or corners of the pieces. Finish sanding with 280 grit sandpaper.

### PRE-ASSEMBLY

A. After sanding, check the proper location and fit of each part by assembling parts loosely, without gluing. Use the **DETAIL VIEWS** as a guide.

B. All parts for X-ACTO kits are made on precision milling machines. When adjustments are required, sand to fit.

# Layout Sheet

Kit 40066

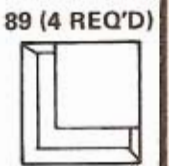
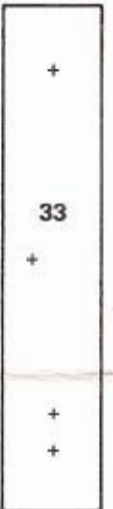
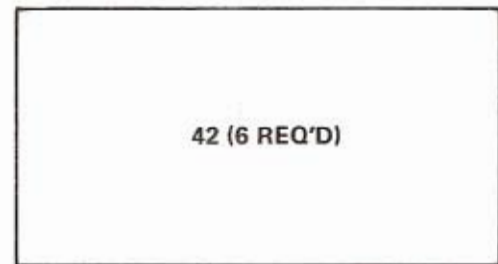
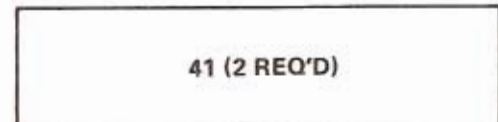
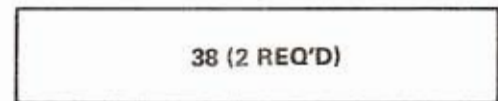
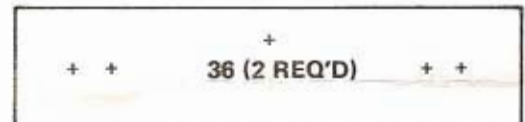
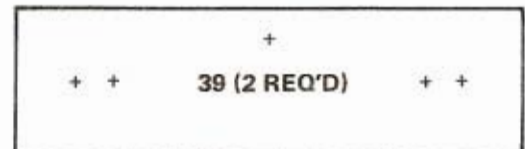
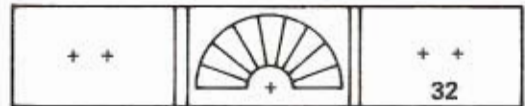
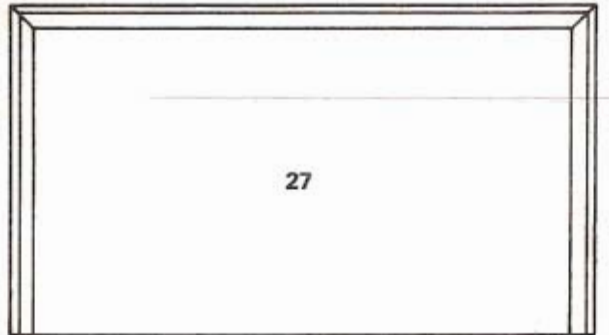
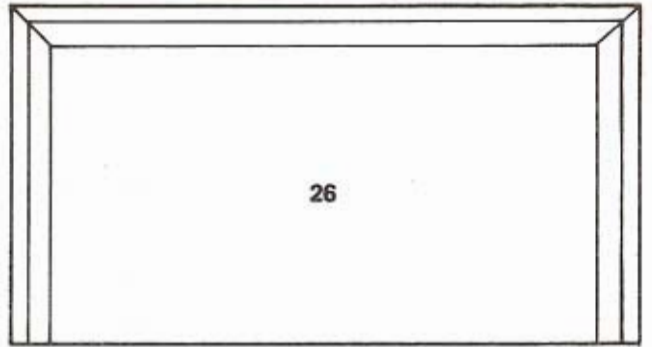
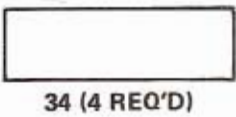
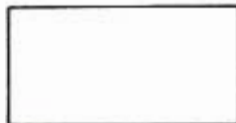
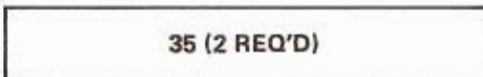
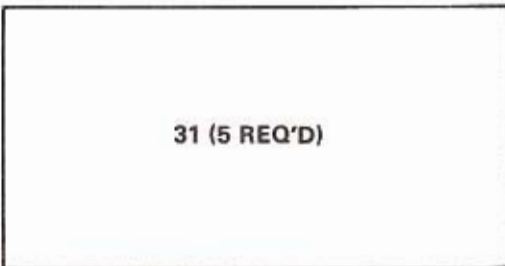
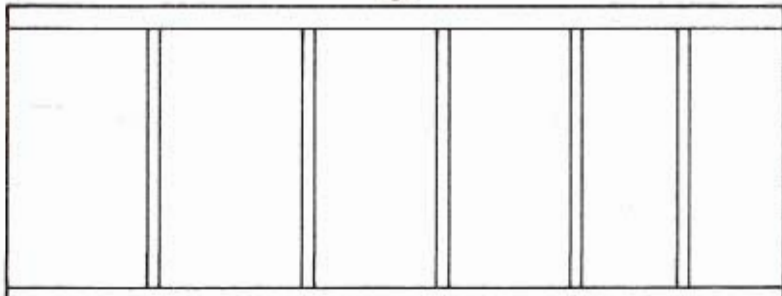
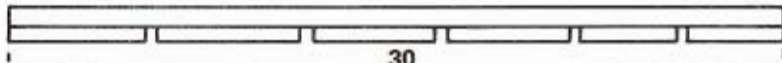
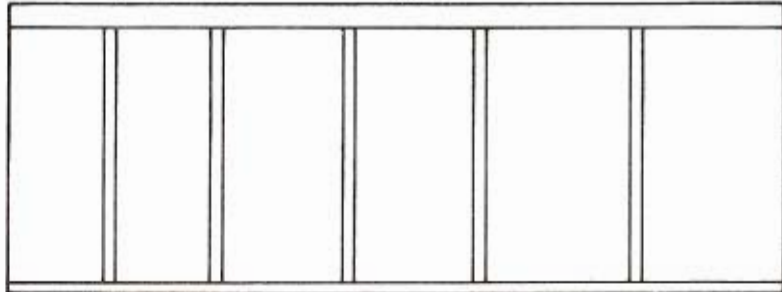
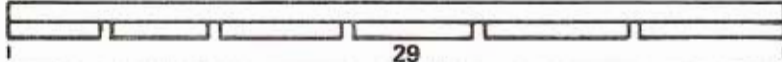
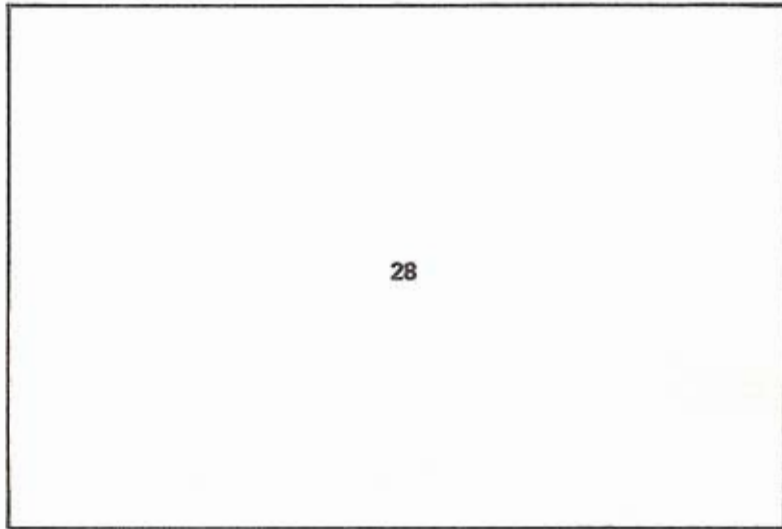

# Detail Views

Kit 40066

## Step 1

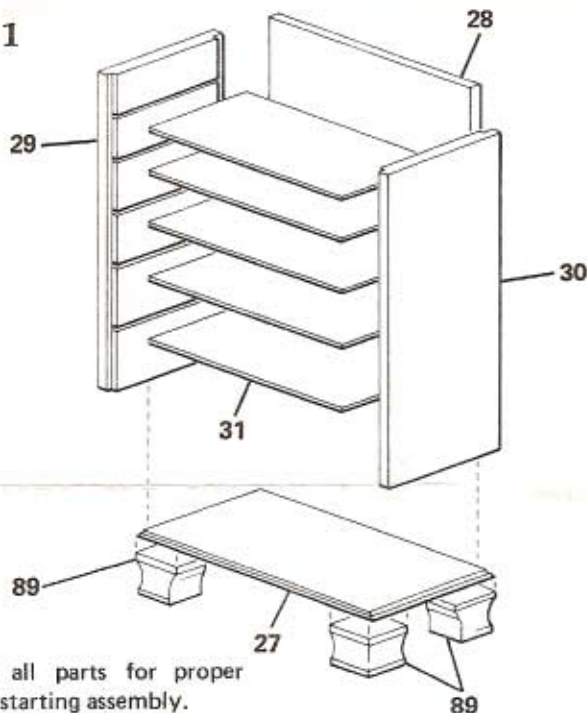

A. Sand all parts for proper fit before starting assembly.

B. Glue the dividers (31) into side (29) and then into side (30). The fronts of the dividers should be flush with the extreme front edges of the sides.

C. Glue the back (28) in place to align the entire case assembly.

D. Glue the feet (89) to the base (27). The shaped edge of the base should face upward when the assembly is complete. The feet should be flush with the edges of the base.

## Step 2



A. Glue the case assembly to the base so that it is centered and the back edges are flush.

B. Glue the top (26) to the case assembly so that it is centered and the back edges are flush.

C. The Chest is now ready to have the final finish applied.

## Step 3

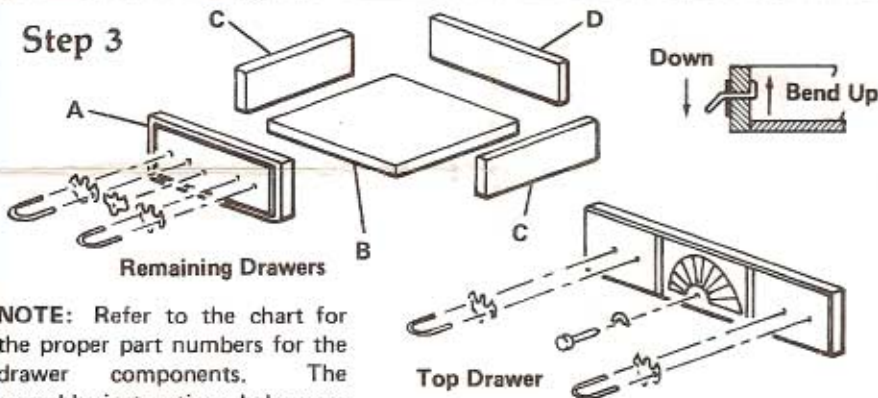

**NOTE:** Refer to the chart for the proper part numbers for the drawer components. The assembly instructions below are typical for all of the drawers.

A. Glue the sides (C) to the bottom (B) so that the front edges and sides are flush.

B. Glue the back (D) to the ends of the sides (C) and to the bottom (B).

C. If the interior of the drawers are not to be stained, apply the final finish to the drawer fronts

(A) before completing the assembly. Fit all of the drawers before finishing them. The drawer fronts are centered on the drawers so that there is an overhang on each end.

D. After the finishing is complete, apply the hardware. Use the guide marks on the

Layout Sheet to locate where to drill the holes for the drawer pulls. The hardware on the top drawer is different from all the rest. The others are installed in the same manner as in the illustration. A drop of white glue on the back of the plates and keyhole plates will hold them in place.

### HARDWARE

Description	Visual	Qty
Knob		1
Plate		12
Handle		12
Plate		1
Keyhole Plate		5

		A	B	C	D
Top Drawer	1	32	42	34	35
	2	33	42	34	35
	3	36	42	37	38
	4	36	42	37	38
	5	39	42	40	41
Bottom	6	39	42	40	41