

COLLECTORS NO. 40064



**Chippendale
Double Chest**
Circa 1780

Chest of drawers evolved from hinged lid chests, or blanket chests, and the addition of drawers gradually led to the elimination of the hinged lid chest portion until eventually all that was left was a "chest of drawers".

This handsome piece of furniture is classed as a Double Chest because of its width and drawer configuration. The wide low design of this chest may have been influenced by where it was to be located in a room, or perhaps it was designed to have a large mirror placed over it.

It was crafted in England in 1780 and finished in a rich mahogany. The nine drawers were outlined with a boxwood inlay and the massive expanse of wood across the front was broken with the eighteen brass drawer pulls.

Colonial homes were often very short of storage space and this large chest was probably a welcome addition to the fine home for which it was designed.

In miniature it is an attractive piece of furniture for any of the larger bedrooms in your house, or if space permits would make an interesting piece to place in a large entry hall.

ASSEMBLY AND FINISHING INSTRUCTIONS



AUTHENTIC REPRODUCTIONS IN MINIATURE

The X-ACTO® House of Miniatures Collectors Series® of furniture and accessories have all been carefully researched by specialists through major museum and library collections to assure the highest quality of authenticity in reproduction. Details are extraordinarily accurate to satisfy the most discriminating miniaturist.

All wood parts are machined to assure accurate and precise acceptance of each piece by another.

For a complete catalog of the X-ACTO® HOUSE OF MINIATURES furniture line and accessories, write to:

THE HOUSE OF MINIATURES
Customer Service - Catalog Dept.
80 Newbridge Road
Bergenfield, NJ 07621

INTRODUCTION

BEFORE STARTING

Identify and account for each part by placing it on the Layout Sheet (make sure the correct layout sheet is used when working on multi-kit Instruction Sheets). Should any parts be missing, send a post card to:

THE HOUSE OF MINIATURES
Customer Service - Parts Dept.
2000 Craftmark Center
Statesville, NC 28677-2000

Please print Name, Address, Part Number (Number from Layout Sheet) and Kit Name and Number on card when ordering.

SANDING

Before assembly, sand all the outer surfaces of individual parts with 220 grit sandpaper, or finer, sanded in the same direction as the wood grain until the surface is smooth. Take care not to round any edges or corners of the pieces. Finish sanding with 280 grit sandpaper.

PRE-ASSEMBLY

- After sanding, check the proper location and fit of each part by assembling parts loosely, without gluing. Use the **DETAIL VIEWS** as a guide.
- All parts for X-ACTO kits are made on precision milling machines. When adjustments are required, sand to fit.

TOOLS AND MATERIALS

A. The following tools will be helpful in constructing this kit:

- X-ACTO Two-inch Sander No. 7042
- X-ACTO Large Clamp No. 7004
- X-ACTO Pin Vise Set No. 7144
- X-ACTO Professional Finishing Kit (or equivalent, see note)
- X-ACTO Pliers No. 7504

B. The following materials will be needed to construct this kit:

- X-ACTO Tinted Glue (see note)
- Sandpaper - 220 and 280 grit
- White glue (or equivalent)
- Small Artist's Brush

NOTE: The X-ACTO tinted glue is matched to the finish used in the Professional Finishing Kit. This will produce the authentic finish of the period in which the original Furniture was produced. When not using X-ACTO glue follow manufacturer's directions.

GLUING

- Glue should be applied in small amounts to surface being joined. When gluing dado joints apply glue to dado only.
- To ensure a tight fit, squeeze excess glue out of the joints. Hold glued parts together with clamps, rubber bands or weights on the parts.
- Wipe off excess glue promptly.
- Be sure a glued assembly has dried thoroughly before adding parts.

FINISHING

The X-ACTO Professional Finishing Kit enables you to finish your furniture by the same process used by the professional furniture maker. The end result is what is important — there are easier methods, but none that will give the quality results that this process will. If you use a finish other than X-ACTO's, refer to the manufacturer's directions.

Layout Sheet

Kit 40064

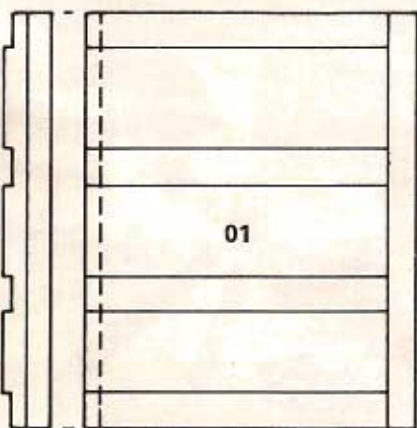
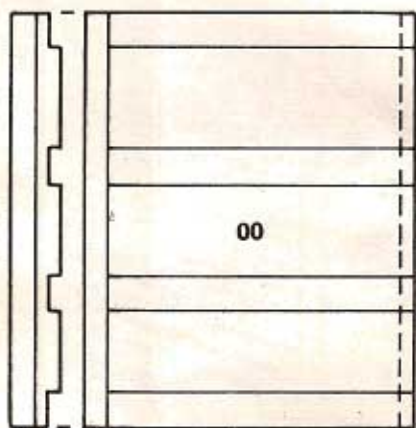

95 (2 REQ'D)



94 (2 REQ'D)

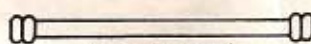

15 (2 REQ'D)

99 (2 REQ'D)

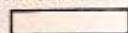

89 (4 REQ'D)

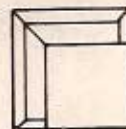

03 (2 REQ'D)

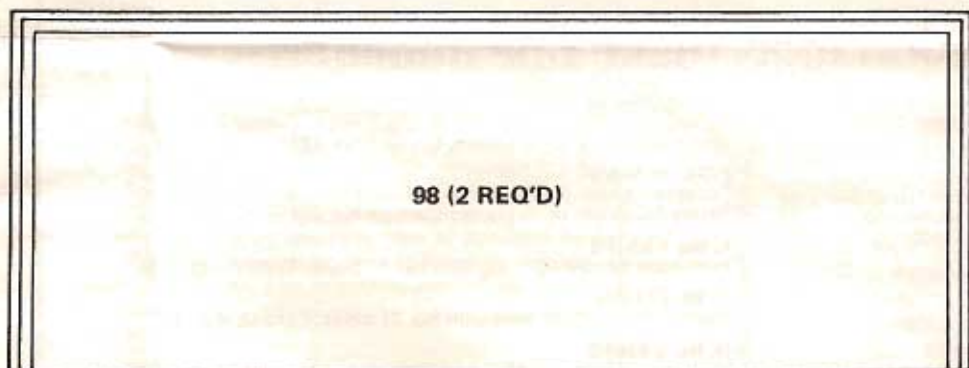

96 (2 REQ'D)

02 (12 REQ'D)

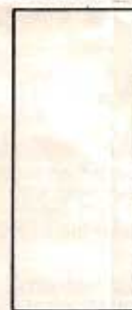

05 (9 REQ'D)

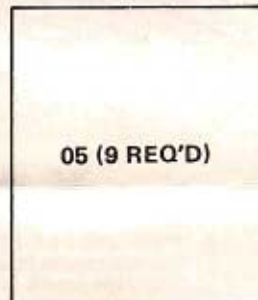

14 (3 REQ'D)

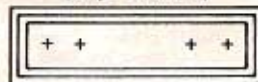

10 (6 REQ'D)

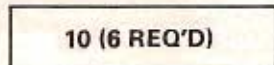

07 (6 REQ'D)

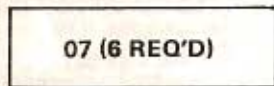

13 (6 REQ'D)

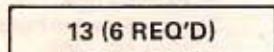

12 (3 REQ'D)

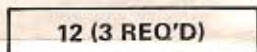

06 (3 REQ'D)

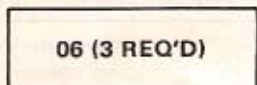

09 (3 REQ'D)

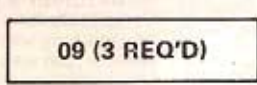

08 (3 REQ'D)

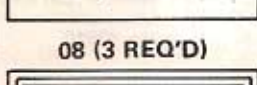

11 (3 REQ'D)

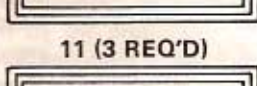

04 (2 REQ'D)

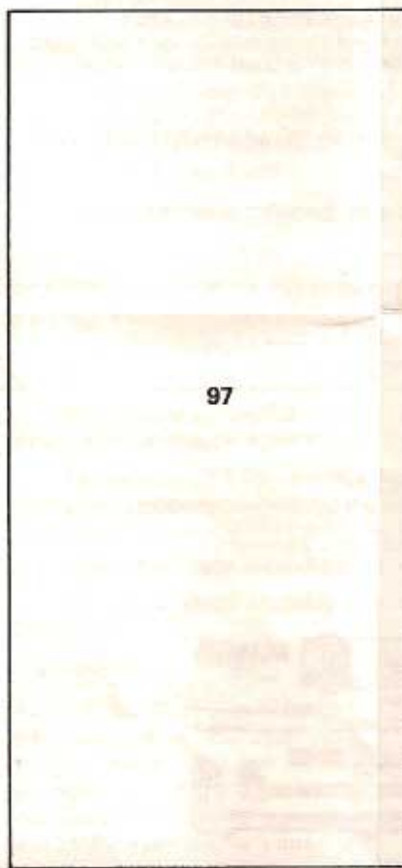
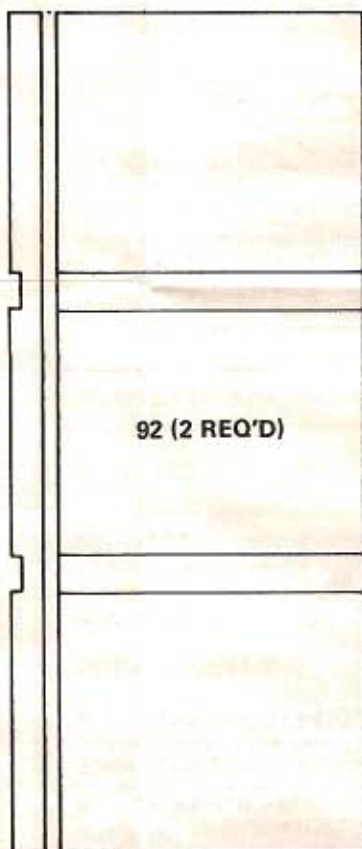

97

Detail Views

Kit 40064

Step 1

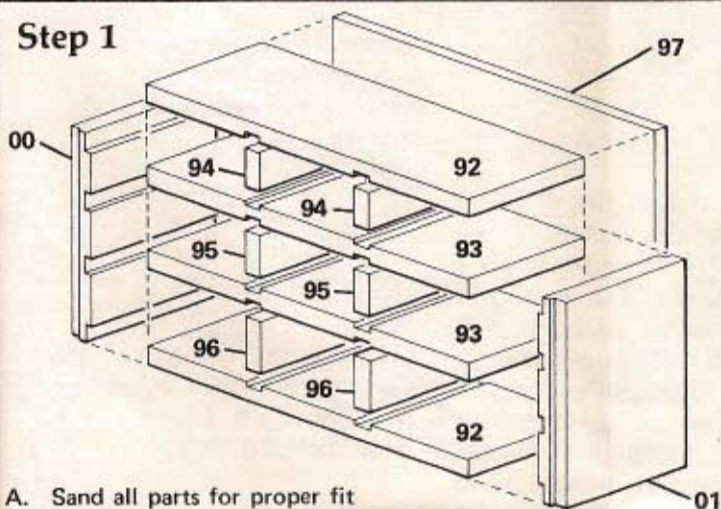

A. Sand all parts for proper fit before assembly.

B. Glue center vertical dividers (95) into the dadoes of the horizontal dividers (93).

C. Glue lower vertical dividers (96) into the horizontal divider (92), then into the bottom of the assembly made in Step B.

D. Glue the upper vertical dividers (94) into the horizontal divider (92) and into the top of the assembly made in Step C.

E. Glue the assembly made in Step D into the ends (00) & (01). Square the entire assembly by gluing the back (97) into place.

Step 2

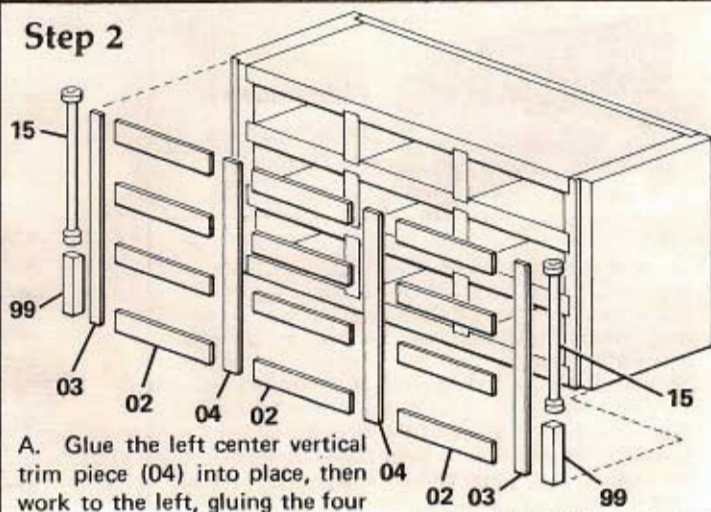

A. Glue the left center vertical trim piece (04) into place, then work to the left, gluing the four horizontal trim pieces (02) in place. Then glue the left vertical trim piece (03) into place.

B. Now work to the right, gluing four horizontal trim pieces (02), then the vertical trim piece (04), then four more horizontal trim pieces (02), and

finally the right vertical trim piece (03).

C. Glue the bottom blocks (99) into the rabbet, formed by the sides and the trim, flush with the bottom. Glue the columns (15) into the rabbet above the bottom blocks.

Step 3



A. Glue the feet (89) to the base (98). The shaped edge of the base should face upward. The back edge of the base should be flush with the back of the case assembly.

B. Glue the top (98) to the case assembly. The shaped edge

should face downward. The back edge of the top should be flush with the back edge of the case assembly.

C. Apply the final finish to this assembly.

Step 4

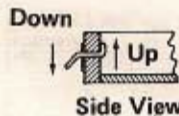
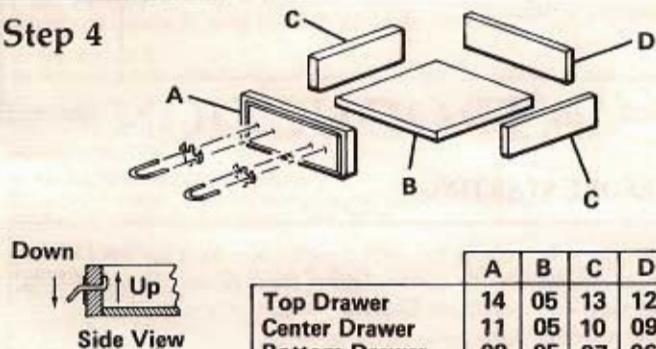

	A	B	C	D
Top Drawer	14	05	13	12
Center Drawer	11	05	10	09
Bottom Drawer	08	05	07	06

HARDWARE CHECKLIST

Description	Visual	Qty
Plate		18
Drawer Pull		18

NOTE: Refer to the chart for part numbers for the individual drawer assemblies. The assembly instructions below are typical for all drawers.

A. Glue the two sides (C) onto the base (B) so that they are flush with the front edge and sides.

B. Glue the back (D) against the ends of the sides (C) and on the bottom (B).

C. If the interior of the drawers are not to be stained apply the final finish to the drawer front (A) before completing assembly. Fit all drawers before finishing.

D. After final finishing install the hardware as illustrated. Use the guide marks on the Layout Sheet to locate where to drill the holes for the pulls. A drop of white glue on the back of the plates will keep them aligned.